

KENWOOD

INSTRUCTION MANUAL

SPECIALIZED COMMUNICATIONS

144/440 MHz FM DUAL BANDER

TM-D700A

144/430 MHz FM DUAL BANDER

TM-D700A

144/430 MHz FM DUAL BANDER

TM-D700E

Downloaded by
RadioAmateur.EU



KENWOOD CORPORATION

© B62-1273-30 (K,E,M)
09 08 07 06 05 04 03 02

CONTENTS

CHAPTER 1 PACKET OPERATION

CONNECTING WITH A PERSONAL COMPUTER	2
OPERATING TNC	3
PREPARATION FLOW	4
SELECTING DATA BAND	5
DCD SENSE	5

CHAPTER 2 DX PACKETCLUSTERS MONITOR

CHAPTER 3 PACSATs

CHAPTER 4 AUTOMATIC PACKET/ POSITION REPORTING SYSTEM®

PACKET PATH AND DIGIPEATER	9
CONNECTING WITH A GPS RECEIVER	10
OPERATION FLOW	11
ADJUSTING THE INTERNAL CLOCK	12
Setting Time	12
Setting Date	12
Setting UTC Offset	13
SELECTING DATA BAND	13
SELECTING PACKET TRANSFER RATE	13
RECEIVING APRS DATA	14
ACCESSING RECEIVED APRS DATA	15
PROGRAMMING A CALL SIGN	17
SELECTING YOUR STATION ICON	18
PROGRAMMING POSITION DATA	19
SELECTING A POSITION COMMENT	20
STORING STATUS TEXT	21
PROGRAMMING A GROUP CODE	22
PROGRAMMING A PACKET PATH	23

SELECTING PACKET TRANSMIT METHOD	25
SELECTING PACKET TRANSMIT INTERVAL	25
SELECTING STATUS TEXT TRANSMIT RATE	25
RESTRICTING RECEPTION OF APRS DATA	26
PROGRAMMING POSITION AMBIGUITY	26
PACKET MONITOR DISPLAY	26
SETTING AS A DIGIPEATER	27

CHAPTER 5 APRS® MESSAGE

OPERATION FLOW	28
RECEIVING A MESSAGE	29
ENTERING A MESSAGE	30
ACCESSING RECEIVED APRS MESSAGES	31
TRANSMITTING A MESSAGE	32
AUTO ANSWER REPLY	33
PROGRAMMING A GROUP CODE	34

CHAPTER 6 SLOW-SCAN TELEVISION (SSTV) WITH VC-H1

CONNECTION WITH VC-H1	35
ENTERING CALL SIGN/ MESSAGE/ RSV	36
SELECTING COLOR FOR CALL SIGN/ MESSAGE/ RSV	37
EXECUTING SUPERIMPOSITION	37
SSTV MODE CHANGE	38
VC-H1 CONTROL	38

CHAPTER 7 TROUBLESHOOTING

APPENDIX

INDEX



MIC KEYPAD DIRECT ENTRY (MC-53DM ONLY)

The keypad on the MC-53DM allows you to enter a call sign, message, or other character strings. The types of characters which you can enter differ depending on the purpose of an entry. Each press of a Mic key switches entry of characters as shown in the tables. You can always use Mic [A] as [➡], [B] as [←], [C] as [DEL], and [D] as [OK].

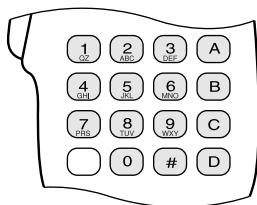

For a call sign {pages 17/ 30}, group code {pages 22/ 34}, packet path {pages 23/ 27}, and SSTV string {page 36}:

1	Q	Z	1		7	P	R	S	7
2	A	B	C	2	8	T	U	V	8
3	D	E	F	3	9	W	X	Y	9
4	G	H	I	4	0	0			
5	J	K	L	5	#	-	, ¹	* ²	/ ³
6	M	N	O	6		! ³	? ³		

¹ Packet path and message/ bulletin group codes only

² Message group code only

³ SSTV string only

For a memory name {page 19}, status text {page 21}, and message {pages 30/ 33}:

1	q	z	1	Q	Z			6	m	n	o	6	M	N	O	
2	a	b	c	2	A	B	C	7	p	r	s	7	P	R	S	
3	d	e	f	3	D	E	F	8	t	u	v	8	T	U	V	
4	g	h	i	4	G	H	I	9	w	x	y	9	W	X	Y	
5	j	k	l	5	J	K	L	0	Space	0						
#	?	!	'	.	,	-	/	&	#	%	()	<	>	;	:
	"	@														

Downloaded by
RadioAmateur.EU

PACKET OPERATION

Packet is a unit of data transmitted as a whole from one computer to another on a network. Packets can be transmitted on radio waves as well as on communications lines. Besides a transceiver and a computer, all you need is a terminal node controller (TNC). A TNC converts packets to audio tones and vice versa as one of its tasks. This transceiver has a built-in TNC.

A variety of packet applications developed by hams include packet bulletin board systems (PBBSs). PBBSs are created and maintained by volunteers called System Operators (SysOp). You may access one of your local PBBSs to send e-mail, download a file, or obtain various useful information. Thousands of PBBSs, which have formed a worldwide network, relay e-mail to its intended destination around the world.

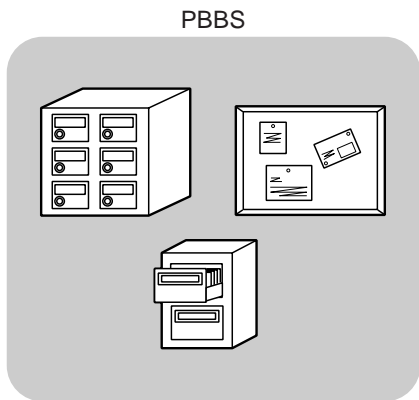

When you access a local PBBS for the first time, you often need to register as a new user. After you are successfully registered, it will then be available as your home PBBS. E-mail addressed to you will be held under a directory, called a mailbox, on your home PBBS.

To send e-mail, you must designate the address of a recipient, using his (or her) call sign and the call sign of his (or her) home PBBS; ex. KD6NUH@KJ6HC. In this example, e-mail is addressed to KD6NUH whose home PBBS is KJ6HC. If your home PBBS cannot find KJ6HC in its address file to forward your mail, you must designate the address in more detail. You may enter "KD6NUH@KJ6HC.#ABC.CA", or "KD6NUH@KJ6HC.#ABC.CA.USA", or up to "KD6NUH@KJ6HC.#ABC.CA.USA.NA", as necessary. The complete address of a recipient living in the U.S., for example, should include an appropriate region code (preceded by a #), state, country, and continent abbreviations as above.

For further information, consult reference books which should be available at any store that handles Amateur Radio equipment. If you are living in the U.S., refer to the ARRL Repeater Directory for packet frequencies. Web pages relating to Packet will also be helpful. On one of the Internet search engines, you may use "Packet Radio" as a key word to find those Web pages.

Note: *If there is an amateur radio club in your area, consider becoming a member. You can learn more in an hour from experienced hobbyists, than in a month of independent research. Ask on the local repeaters, or contact your national amateur radio organization (in the U.S., the ARRL) for information on local amateur radio clubs. You'll be glad you did.*

CONNECTING WITH A PERSONAL COMPUTER

1

Use a commercially available RS-232-C straight cable to connect the transceiver to a personal computer. This transceiver has a DB-9 male connector on the front of the main unit.

Note: Turn OFF the transceiver power before making the connections.

Pin No.	Pin Name (Ref: Computer)	Function (Ref: TM-D700)
1	DCD	—
2	RXD	TX data
3	TXD	RX data
4	DTR	Data Terminal Ready
5	GND	Signal ground
6	DSR	Data Set Ready
7	RTS	RX enable
8	CTS	TX enable
9	RI	—

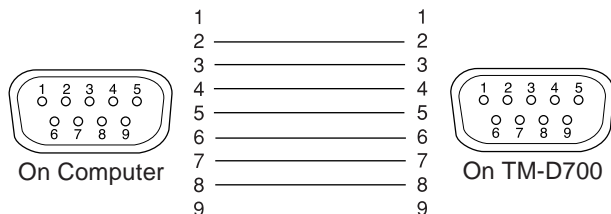

To connect an external TNC to the transceiver, use an optional PG-5A cable. The DATA connector on the front of the main unit mates with a 6-pin mini DIN plug on this cable.

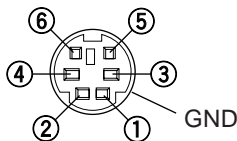

Pin No.	Pin Name	Function
1	PKD	Packet data input <ul style="list-style-type: none"> • TX data from TNC to transceiver
2	DE	Ground for PKD
3	PKS	Packet standby <ul style="list-style-type: none"> • TNC can use this pin to inhibit the transceiver microphone input while transmitting packet signals.
4	PR9	Output of detected 9600 bps data (500 mV _{P-P} , 10 kΩ) <ul style="list-style-type: none"> • Also functions as a common pin for 1200 bps and 9600 bps data output.
5	PR1	Output of detected 1200 bps data (500 mV _{P-P} , 10 kΩ)
6	SQC	Squelch control output <ul style="list-style-type: none"> • Inhibits TNC data transmitting while transceiver squelch is open. • Prevents interference to voice communications on the same frequency. Also prevents retries. • Output Level Open squelch: +5 V (High) Closed squelch: 0 V (Low)

Note:

- ◆ If the external TNC has a common pin for 1200 bps and 9600 bps data input, connect this pin to the DATA connector PR9 pin. Shorting the PR9 and PR1 pins will cause the TNC to malfunction.
- ◆ If DC voltage is input to the PR1 pin, the external TNC may not function. If this problem happens, add a 10 μF capacitor between the PR1 pin and the TNC. Be careful with the polarity of the capacitor.

OPERATING TNC

This transceiver has a built-in TNC which conforms to the AX.25 protocol. This protocol is used for communications between TNCs. The TNC accepts data from your personal computer and assembles it into packets. It then converts packets to audio tones which the transceiver can transmit. The TNC also takes audio tones from the transceiver, converts them to data for the computer, and checks for errors in the data.

The TNC mainly functions in Command or Converse mode. First learn the difference between these two modes.

- **Command mode**

When you select Packet mode, the TNC enters this mode. A “cmd:” prompt appears on the computer screen. You can type commands from the computer keyboard to change the settings on the TNC. When in Converse mode, press **[Ctrl]+[C]** on the keyboard to restore the Command mode.

- **Converse mode**

The TNC enters this mode when a linkage with the target station is established. On the computer keyboard, type an appropriate command and if necessary a message, then press **[Enter]** or **[Return]**. What you type is converted into packets and transmitted over the air. When in Command mode, type CONVERSE to restore the Converse mode; you can also type CONV or K instead.

For the commands supported by the built-in TNC, see “TNC COMMANDS LIST” on page 41.

The following indicators appear on the transceiver display to show the current TNC status:

Indicator	Status
TNC PKT	The TNC is in Packet mode.
STA	Packets to be transmitted still remain in the buffer.
CON	The TNC is in connection with the target station.
MBOD	The mailbox in the TNC is being accessed or connected by the other station.
MAIL	The mailbox in the TNC holds mail addressed to you.
1200	1200 bps transfer rate selected
9600	9600 bps transfer rate selected

The built-in TNC includes a simple mailbox to directly receive mail from other stations; the mailbox holds up to approximately 110 kilobytes (KB) of information. You can read mail from the mailbox by sending a command from your personal computer {page 47}.

Note:

- ◆ *Not all functions available via conventional TNCs are supported by the TNC built in this transceiver.*
- ◆ *The built-in TNC could be automatically reinitiated when its malfunction is detected; this does not designate that the transceiver is defective.*
- ◆ *To distinguish your various stations or nodes, you can have up to 15 Secondary Station IDentifiers (SSIDs); ex. WD6BQD-1 to WD6BQD-15. You always have to put a dash between your call sign and SSID number.*
- ◆ *Packet operation, easily affected by transmit and receive conditions, requires a full-scale S-meter reading for reliable communication. When the S-meter reads less than maximum during 9600 bps operation, communication errors are frequent.*

PREPARATION FLOW

1 The following steps should guide you to a good start of packet operation. The shaded steps indicate operations on your personal computer. First connect the transceiver to the personal computer {page 2}.

Note: You must not change the default (9600 bps) in Menu 1–9–5 (COM PORT).

- 1 Install an appropriate terminal program on the personal computer.
 - A variety of freeware or shareware programs can be obtained in various ways. Consult your reference material or other “packetees”.

- 2 Initiate the terminal program and set the following parameters on the personal computer:
 - Transfer rate (TNC ↔ Computer): 9600 bps
 - Data length: 8 bit
 - Stop bit: 1 bit
 - Parity: Non
 - Flow control: Hardware

- 3 Access Menu 1–6–1 to select band A or B as the data band {page 5}.

- 4 Press **[F] (1 s)**, **[TNC]**, then **[F] (1 s)**, **[TNC]** again to enter Packet mode.
 - “**TNC PKT**” should appear.

- 5 To select 9600 bps as the transfer rate from/to the target station, type HBAUD (or HB) 9600 and press **[Enter]** or **[Return]**. The default is 1200 bps.
 - You must select the same transfer rate as the target station.

- 6 Type MYCALL (or MY) then your call sign (9 digits max.) and press **[Enter]** or **[Return]** to set your call sign on the TNC.
 - You cannot use the default setting (NOCALL).

- 7 Tune to an appropriate frequency.
 - First you may want to monitor packets which are transmitted among other stations. When packets are received, text appears and the computer screen scrolls.

- 8 To connect with the target station, type CONNECT (or C) then its call sign and press **[Enter]** or **[Return]**.
 - When a linkage is established, a message informing you of this appears on the computer screen; on the transceiver display, “**CON**” appears.
 - If packets from other stations keep your squelch open, adjust the squelch level in advance. The TNC cannot transmit while the squelch is opened.

- 9 Send appropriate commands and, if necessary, messages to the target station via the TNC.

SELECTING DATA BAND

This transceiver is capable of receiving packet data on one band (data band) while receiving audio on the other band. In order to use the built-in TNC, access Menu 1–6–1 (DATA BAND) and select band A or B as the data band for receiving or transmitting packets. “**D**” indicates the current data band; the default is band A.



Note:

- ◆ In Menu 1–6–1, the selection switches among A, B, A:TX B:RX, and A:RX B:TX. Select A:TX B:RX or A:RX B:TX when accessing a PACSAT (page 7).
- ◆ The selection in Menu 1–6–1 is invalid for an external TNC. Use the TX band to transmit and receive packets through an external TNC. When using an external TNC, access Menu 1–9–6 (DATA SPEED) and select 1200 bps (default) or 9600 bps as the transfer rate between TNCs. This selection is valid only for an external TNC.

TM-D700E Only: Do not select the narrow transmit deviation on the data band.

DCD SENSE

You can also select the method for inhibiting the built-in TNC from transmitting. Access Menu 1–6–2 (DCD SENSE) and select one of the two methods. The default is “DATA (RX) BAND”.

DATA (RX) BAND	The TNC does not transmit when signals are present on the data band (D) or RX data band (R:D).
A AND B BANDS	The TNC does not transmit when signals are present on band A or B.



DX PACKETCLUSTERS MONITOR

DX PacketClusters are networks which consist of nodes and stations who are interested in DXing and contesting. If one station finds a DX station on the air, he (or she) sends a notice to his (or her) node. Then this node passes the information to all its local stations besides another node. This transceiver can display received DX information and hold the latest information on up to 10 DX stations. Use this function to monitor the latest DX information in your local area. You cannot send DX information to a node, using the function.

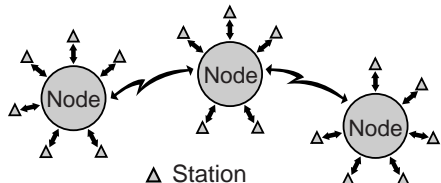

- 1 Access Menu 3-I (DATA BAND) to select band A or B.
 - If the common transfer rate in your local PacketCluster network is 9600 bps, access Menu 3-J (PACKET SPEED) and select "9600 bps" (page 13).
- 2 Tune to the frequency of the target PacketCluster node.
- 3 Press [F] (1 s), [TNC] to enter APRS mode.
 - "TNC APRS" should appear.
- 4 Press [F] (1 s), [DX].
 - Each time new DX cluster data is received, a call sign, frequency, and time are displayed.
 - Information of up to 5 DX stations are displayed at the same time.
 - When a duplicate DX cluster data is received, "dD" and a call sign are displayed.

		Frequency	Time
50	TNC APRS	1200	
50	▶ 1:KD6NUH	14230.0	1727Z
	2:KJ6HC	7083.0	1721Z
	3:WB6LMN	21125.0	1715Z
	4:WA4GDX	14300.0	1708Z
	5:KA6EHF	7069.0	1703Z
	ESC DEL ↑ ↓	OK	CLR

50	Displays the list of the previous 5 DX stations.	50	Displays the list of the next 5 DX stations.
ESC	Restores the frequency display.	DEL	Deletes the current DX station.
↑	Moves the cursor upward.	↓	Moves the cursor downward.
OK	Displays a comment attached to the current DX station.	CLR (left BAND SEL)	Deletes all DX stations.

- 5 To read an attached comment, move the cursor (▶) to the desired station using [↑]/[↓], then press [OK].
 - Up to 30 alphanumeric characters are displayed as a comment.

TNC APRS	7069.0	1734Z
▶ 5:KA6EHF		
0123456789ABCDE FGHIJKLMNOPQRST		
BACK DEL ↑ ↓		

BACK	Restores the list of DX stations.
DEL	Deletes the entire information of the current DX station.
↑ / ↓	Displays the information of the other DX stations.

Note: The information is cleared when the transceiver power is turned OFF.

PACSATs

PACSATs refer to satellites designed and launched for digital communications using the AX.25 protocol. Several PACSATs are currently in orbit serving thousands of hams throughout the world. The PACSATs receive (uplink) on VHF and transmit (downlink) on UHF. Some of them use FM to receive and SSB to transmit, and operate at 1200 bps. The others use FM to both receive and transmit, and operate at 9600 bps. This transceiver allows communications with the 9600 bps satellites. The PACSATs provide functions similar to terrestrial PBBSs. You can use the satellites to send e-mail, download a file, or enjoy other fascinating activities. From the satellites equipped with high resolution cameras, you may download still pictures taken in space.

In order to work the PACSATs, you need rotators that allow azimuth and elevation control, plus high-gain directional antennas. Your antenna has to track satellites which travel from horizon to horizon. However, many hams have been successfully using fixed omnidirectional antennas. As for software, you need dedicated programs capable of working the “broadcast” protocols. Besides the “broadcast” programs, various utilities which will ease your operations are available via the Web pages of the Radio Amateur Satellite Corporation (AMSAT); the world wide organization of Amateur Satellite operators and supporters.

For further information, consult Internet Web pages relating to the PACSATs. On one of the Internet search engines, you may use “PACSAT” or “AMSAT” as a key word to find those Web pages. It will also be wise to ask help to one of your local satellite packeteers.

- 1 Access Menu 1-6-1 (DATA BAND) to select A:TX B:RX (or A:RX B:TX).



A:TX B:RX	Uses band A to transmit packets and band B to receive packets; band A = data TX band, band B = data RX band.
A:RX B:TX	Uses band A to receive packets and band B to transmit packets; band A = data RX band, band B = data TX band.

- 2 Confirm that a VHF band has been recalled on the data TX band.
- 3 Tune the data TX band to the uplink frequency of the target PACSAT.
- 4 Confirm that a UHF band has been recalled on the data RX band.
- 5 Tune the data RX band to the downlink frequency of the PACSAT.
- 6 Press **[F] (1 s)**, **[TNC]**, then **[F] (1 s)**, **[TNC]** again to enter Packet mode.
 - “**TNC PKT**” should appear.

For the subsequent steps, follow the manual for the “broadcast” program and your reference material.

AUTOMATIC PACKET/ POSITION REPORTING SYSTEM[®]

The Automatic Packet/ Position Reporting System (APRS[®]) is a software program and registered trademark of Bob Bruninga, WB4APR. He has made packet communications much more exciting than before. This program allows you to track mobile stations on a map which you recall on a computer screen. Imagine seeing one mobile station moving on the map which can be scaled from .5 to 2000 miles. You also may be tracked on the computer screen of another station. Stations to be tracked must transmit beacons at certain intervals. To track other stations, you usually need a computer running the APRS, a transceiver, and a TNC. To have them track you, you also need a GPS receiver. It receives signals from the satellites to inform you of your current geographical position. GPS stands for Global Positioning System. The APRS interprets the National Marine Electronics Association (NMEA) data strings coming from the GPS receiver. For further information, consult Internet Web pages relating to the APRS. On one of the Internet search engines, you may use "APRS" or "Packet Radio" as a key word to find those Web pages.



This transceiver includes a TNC and a program for dealing with data formats supported by the APRS. That is, you need no other equipment to transmit, receive, or display APRS packets. You do not need even a GPS receiver if you enter position data manually to transmit. For hams who want to fully enjoy APRS operations, this transceiver has connection ports with a personal computer and a GPS receiver. This manual, however, does not describe APRS operations which require a personal computer.

Using this transceiver, you can transmit a station icon, position data, position comment, and status text. With a GPS receiver, you can also transmit moving speed, moving direction, and altitude data. From any type of station you will receive information listed below:

Station icon	Position data/ Grid square locator
Position comment	Status text
Distance from station	Direction of station

Depending on the types of stations, you will also receive the following information:

Mobile station	Moving direction/ Moving speed
Fixed station	Transmit power/ Height of antenna/ Antenna gain/ Antenna directivity
Fixed station (using compressed APRS data format)	Transmit range/ Altitude
Weather station	Wind direction/ Wind speed/ Temperature/ Rainfall in last hour

PACKET PATH AND DIGIPEATER

A packet path specifies how APRS packets should be transferred via one or more repeaters. A repeater, which is used for packet transfer, is commonly called a digipeater. This came from a “digital repeater”. A digipeater is usually located on a mountain top or high building. Unlike a voice repeater, it operates on a simplex frequency. Each volunteer who installs a digipeater programs it either as a WIDE or RELAY type. Generally a WIDE transmits packets over much greater distances than a RELAY.

In any given area, there should be only one WIDE not to cause extra traffic or collisions on frequencies. A WIDE is capable of transferring packets from and to adjacent WIDEs. Like a WIDE, there should be only one RELAY in a given area; that area is usually much smaller than a WIDE. So, transmit packets to a RELAY when you cannot directly reach any WIDE. The RELAY then will transfer the packets to any accessible WIDE.

On this transceiver, you can edit a packet path using a maximum of 79 alphanumeric characters. The default is “RELAY,WIDE” that is one of the common settings. With this setting, packets will be transferred to a RELAY first, then to a WIDE.

The APRS supports various methods for specifying a packet path. Some of those methods are described on page 24.

This transceiver with a built-in TNC may be used as a digipeater. See page 27.

Note: To serve for mobile stations who always use the RELAY,WIDE path, most WIDEs also respond to packets addressed to a RELAY.

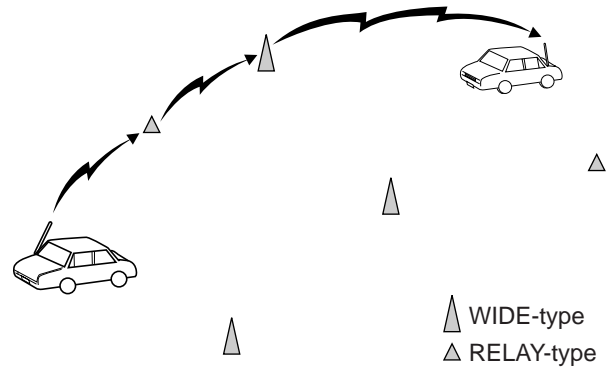

CONNECTING WITH A GPS RECEIVER

The **GPS** jack on this transceiver accepts a 2.5 mm (1/10") 3-conductor plug. If necessary, use the supplied cable to modify the cable end of your GPS receiver.

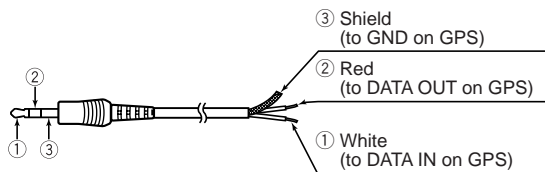
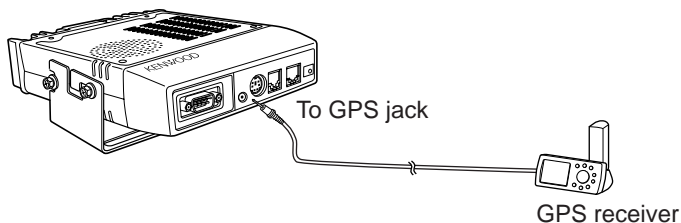

If using a GARMIN GPS receiver, select the following parameters in the "INTERFACE" sub-menu on the receiver.

- NMEA/NMEA
- NMEA 0183 2.0
- 4800 baud

In order to use the connected GPS receiver, access Menu 3-2 (GPS UNIT) to select "NMEA" or "NMEA96". The default is "NOT USED". Select "NMEA96" when using a 9600 bps GPS receiver.

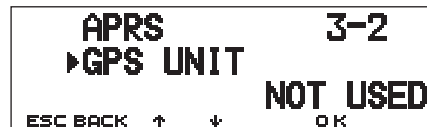

- When in APRS mode, "GPS" will appear on the restored frequency display to indicate the setting of "NMEA" or "NMEA96". "GPS" blinks while measurement is being executed.

Note: When using a GPS receiver with "AUTO" selected in Menu 3-C (PACKET TX), this transceiver transmits an APRS packet for the first time after any NMEA data is received.

OPERATION FLOW

The following flow chart includes only the steps to give APRS a quick try.

① Access Menu 3-I to select band A or B as the data band {page 13}. The default is band A.

② Press **[F] (1 s)**, **[TNC]** to enter APRS mode.

- “**TNC APRS**” should appear.

③ On the data band, select the same frequency as other stations in your group.

- You may tune to the frequency of an appropriate digipeater network (144.390 MHz in the U.S.) {page 9}.

Now you are ready to receive APRS packets from other stations. Refer to “RECEIVING APRS DATA” {page 14}. To transmit your APRS packet, proceed to step ④.

④ Access Menu 3-1 to program your call sign (9 digits max.) {page 17}.

⑤ If you have connected a GPS receiver, access Menu 3-2 and select “NMEA” or “NMEA96” {page 10}. The default is “NOT USED”.

⑥ Access Menu 3-8 to select your station icon {page 18}.

⑦ Access Menu 3-4 to program position data {page 19}.

⑧ Access Menu 3-6 to select from 15 position comments {page 20}.

⑨ If you want, access Menu 3-9 to enter status text using up to 28 alphanumeric characters {page 21}.

⑩ Access Menu 3-C to select the operation method for transmitting packets {page 25}.

⑪ Press **[F] (1 s)**, **[BCON]**. If you selected “PTT” in step ⑩, then press and release Mic **[PTT]** {page 25}.

When using a personal computer, press **[F] (1 s)**, **[TNC]**, then **[F] (1 s)**, **[TNC]** again in step ② to enter Packet mode; “**TNC PKT**” should appear. All further operations should be performed on your computer.

Menu Set-up allows you to change various default settings for APRS operations. See the appropriate sections in this chapter.

4

ADJUSTING THE INTERNAL CLOCK

This transceiver has a clock to manage information on when APRS packets are received. Use Menu Set-up to correct the current time, date, and if necessary the UTC offset; UTC stands for Universal Time Coordinated.

■ Setting Time

- 1 Press **[MNU]** to enter Menu mode.
- 2 Press **[↑]/ [↓]** to select “RADIO (1–)”, then press **[OK]**.
- 3 Press **[↑]/ [↓]** to select “TNC (1–6–)”, then press **[OK]**.
- 4 Press **[↑]/ [↓]** to select Menu 1–6–3 (TIME), then press **[OK]**.
 - The first 2 digits blink.



- 5 Press **[↑]/ [↓]** to enter the current hour, then press **[OK]**.
 - To set 1 o'clock PM for example, select 13.
 - The next 2 digits blink.
- 6 Press **[↑]/ [↓]** to enter the current minute, then press **[OK]**.
- 7 Press **[MNU]** to exit Menu mode.

■ Setting Date

- 1 Press **[MNU]** to enter Menu mode.
- 2 Press **[↑]/ [↓]** to select “RADIO (1–)”, then press **[OK]**.
- 3 Press **[↑]/ [↓]** to select “TNC (1–6–)”, then press **[OK]**.
- 4 Press **[↑]/ [↓]** to select Menu 1–6–4 (DATE), then press **[OK]**.
 - The first 2 digits blink.



- 5 Press **[↑]/ [↓]** to enter the current month (U.S.A./ Canada) or day, then press **[OK]**.
 - The next 2 digits blink.
- 6 Press **[↑]/ [↓]** to enter the current day (U.S.A./ Canada) or month, then press **[OK]**.
 - The last 2 digits blink.
- 7 Press **[↑]/ [↓]** to enter the current year, then press **[OK]**.
- 8 Press **[MNU]** to exit Menu mode.

Note:

- ◆ If you disconnect and reconnect the flexible cable between the radio and TNC boards to replace the lithium battery, be sure to reset the clock IC. Press **[REV]+[LOW]+ POWER ON**.
- ◆ When used at room temperature (25°C), the error of the internal clock in a month is within one minute.
- ◆ The internal clock is effective until December 31, 2098.

■ Setting UTC Offset

- 1 Press **[MNU]** to enter Menu mode.
- 2 Press **[↑]/ [↓]** to select “RADIO (1–)”, then press **[OK]**.
- 3 Press **[↑]/ [↓]** to select “TNC (1–6–)”, then press **[OK]**.
- 4 Select Menu 1–6–5 (TIME ZONE), then press **[OK]**.

```
TNC          1-6-5
▶TIME ZONE
ESC BACK ↑ ↓ OK UTC
```

- 5 Press **[↑]/ [↓]** to select the appropriate UTC offset, then press **[OK]**.
 - The selectable range is from +12:00 to –12:00 in steps of 30 minutes.
- 6 Press **[MNU]** to exit Menu mode.

Downloaded by
RadioAmateur.EU

SELECTING DATA BAND

On this transceiver you can select data band for APRS mode independent of the selection (in Menu 1–6–1) for Packet mode. Access Menu 3–I (DATA BAND) and select band A or B as the data band for receiving or transmitting APRS packets. The default is band A. “**I**” indicates the current data band.

```
APRS          3-I
▶DATA BAND
ESC BACK ↑ ↓ OK A
```

Note: In Menu 3–I, the selection switches among A, B, A:TX B:RX, and A:RX B:TX. Select A:TX B:RX or A:RX B:TX if APRS networks which use two separate frequencies become available in the future.

SELECTING PACKET TRANSFER RATE

The default APRS packet transfer rate set on the built-in TNC is 1200 bps which is the standard among the current APRS networks. If APRS networks which use 9600 bps transfer rate become available in the future, access Menu 3–J (PACKET SPEED) and select “9600 bps”.

```
APRS          3-J
▶PACKET SPEED
1200 bps
ESC BACK ↑ ↓ OK
```

RECEIVING APRS DATA

Each time a new APRS packet is received, the frequency display is interrupted to show information as below:

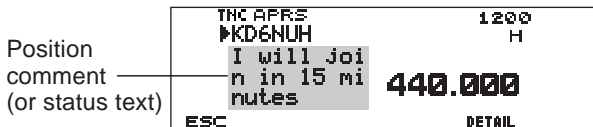

- The received APRS packet may include information on an object such as a hurricane or tornado. In this case, the name of the object appears instead of a call sign.
- Press **[DETAIL]** to access further information {page 15}.
- To restore the frequency display, press **[ESC]** or just wait for approximately 10 seconds.

Note:

- ◆ When you receive an APRS packet including an “Emergency” comment, a different format of display from the above will appear and a different beep will sound.
- ◆ When you receive an APRS position packet that you transmitted, the frequency display is not interrupted. “MY POS” will appear on the display. This could happen when one or more digipeaters {page 9} are used. If you receive a message {page 30} that you transmitted, “MY MESSAGE” will appear.

If a received packet does not include new (or proper) APRS data, the frequency display is not interrupted. An indicator such as “dP” appears depending on the types of data. See the table.



Indicator	Meaning	What is Included?
dP	Duplicate position comment	Same comment as the previous one from the same station
dS	Duplicate status text	Status text already received
>P	Beyond position limit	Data from a station outside the selected range {page 26}
Q? ¹	Query	Request for sending information
??	Packet that cannot be decoded	

¹ The transceiver automatically transmits the appropriate information in approximately 2 minutes after receiving a request.

Note: The APRS programs for PCs have entry fields for a position comment and status text. The data entered to these two fields are transmitted as separate packets. This transceiver, however, includes both of a position comment and status text in one packet to transmit.

This transceiver beeps each time it receives any type of APRS packet. You may access Menu 3–F (BEEP) to change this setting. The default is “ALL”. The selection in this menu is shared with APRS Message {page 29}.

Selections	New Packet	Duplicate Packet	Invalid Packet
OFF	No beep	No beep	No beep
MINE	This selection is valid only for APRS Message {page 29}.		
ALL NEW	Beep	No beep	No beep
ALL	Beep	Beep	Beep

ACCESSING RECEIVED APRS DATA

This transceiver is capable of receiving and storing APRS data received from up to 40 stations in memory. You can easily recall the information of the desired station.

1 Press [F] (1 s), [LIST].

- The list of stations appears.
- The numbers beside the call signs indicate the order in which data is received. The data received last is assigned 1.

```

5↑ TNC APRS 1200
  1:KJ6HC 17:23 WEATHER
  2:WB6LMN-3 17:21 MOVING
  3:WB4APR 17:14 FIXED
  4:W3ADD-1 17:10 MOVING
  5:KA6EHF 17:00 TH-D7
ESC DEL ↑ ↓ MSG OK CLR
    
```

Situation

5↑	Displays the list of the previous 5 stations.	5↓	Displays the list of the next 5 stations.
ESC	Restores the frequency display.	DEL	Deletes the current station.
↑	Moves the cursor upward.	↓	Moves the cursor downward.
MSG	Allows message entry to the current station {page 30}.	CLR (left BAND SEL)	Deletes all stations.

2 Press [↑]/[↓] to select the desired station using the cursor (▶).

3 Press [OK].

- The information of the selected station appears.

```

TNC APRS 1200
▶ 3:WB4APR 17:14 FIXED
  N 39° 09.50' 1510mi
  W076° 35.50' FM19GD 045°
I will leave home soon.
BACK DEL ↑ ↓ MSG DATE
    
```

BACK	Restores the list of stations.
DEL	Deletes the entire information of the current station.
↑ / ↓	Displays the information of the other stations.
MSG	Allows message entry to the current station {page 30}.
DATE	Switches between time and date for received data.

- Depending on the types of stations, different types of information will appear. For details, see the next page.

Note:

- When data from the 41st station is received, the oldest data in memory is replaced by that data.
- Each time a new APRS packet is received from the same station, the old data from that station (in memory) is replaced by new data.

When APRS data is received with a GPS receiver connected, included position data is sent to the receiver, using the NMEA-0183 \$GPWPL format (or Magellan format). This data is registered in the Waypoint List of the receiver. Access Menu 3–3 (WAYPOINT) and select the number of characters to be input. You can select 6 to 9 digits for NMEA, 6 digits for Magellan, DGPS, or OFF (default). With NMEA 6 digits selected, the right 6 characters of the call sign is used as a name (ex. for KJ6HC-3, J6HC-3). Select DGPS to input differential position data to a DGPS-compatible receiver if it is connected.

The information of the selected station is shown using up to 5 lines on the display. The first three lines and the fifth line show the same types of information while the fourth line shows different types of information depending on the types of stations.

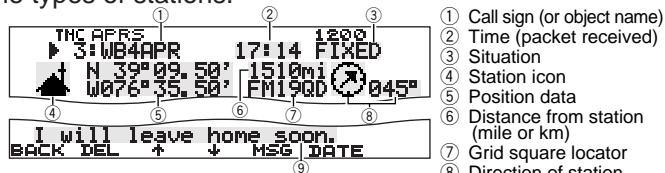

1 For packets received from Mic-encoder stations including TM-D700s and TH-D7s, position comments are displayed in the fourth line.

- 1 Call sign (or object name)
- 2 Time (packet received)
- 3 Situation
- 4 Station icon
- 5 Position data
- 6 Distance from station (mile or km)
- 7 Grid square locator
- 8 Direction of station
- 9 Position comment 1 (or status text)

4

This transceiver is capable of displaying the following 19 icons as station IDs. When icon data other than these is received, the display will show an icon code such as /\$ or \\$.



Some icons may appear with overlay characters as below if the received icon data includes them.



The following icons show the directions of stations relative to your position. For example, "↗" indicates the other station is located at the northeast relative to your position.



0.0 to 9999 miles (or km) are shown for distances from other stations. "xxxxmi" (or "xxxxkm") is shown for distances over 9999 miles (or km). If you do not change the position data in Menu 3-4 from the default, "----mi" (or "----km") is shown.

The default units for distance and temperature differ depending on market versions; mile/ °F for the U.S.A./ Canada version, and kilometer/ °C for the other market versions. If necessary, access Menu 3-G (MILE/ KILOMETER) and/or Menu 3-H (TEMPERATURE) to change the setting(s).

Note: Some stations transmit APRS packets through TNCs connected to GPS receivers. If you receive packets from those stations, "GOOD" (satellites tracked) or "LAST" (satellites not tracked) will be shown as the situation, with GLL, GGA, or RMC which designates \$GPGLL, \$GPGGA, or \$GPRMC format.

Mobile station	Fixed station
cse112° s064m	fw25w h0040° ant7dB d123°
<ol style="list-style-type: none"> 1 Moving direction 2 Moving speed m: Mile/hour k: km/hour 	<ol style="list-style-type: none"> 1 Transmit power 2 Height of antenna (elevation) 3 Antenna gain 4 Antenna directivity (omni: Omnidirectional)
Weather station	Object (page 14)
dir042° s001m t011°F r0.00°	cse112° s064m from:KD6ZZU-5
<ol style="list-style-type: none"> 1 Wind direction 2 Wind speed 3 Temperature 4 Amount of rainfall in the past hour (" or mm) 	<ol style="list-style-type: none"> 1 Moving direction 2 Moving speed m: Mile/hour k: km/hour 3 Call sign
Mobile station (compressed APRS data format)	Fixed station (compressed APRS data format)
cse123° s064m alt000050°	range0236mi alt000050°
<ol style="list-style-type: none"> 1 Moving direction 2 Moving speed m: Mile/hour k: km/hour 3 Altitude ' : Feet M: Meter 	<ol style="list-style-type: none"> 1 Transmit range (mile or km) 2 Altitude ' : Feet M: Meter
TM-D700	TH-D7/ Mic Encoder
Enroute 112° 064m a000050°	Enroute cse123° s064m
<ol style="list-style-type: none"> 1 Position comment 2 Moving direction 3 Moving speed m: Mile/hour k: km/hour 4 Altitude ' : Feet M: Meter 	<ol style="list-style-type: none"> 1 Position comment 2 Moving direction 3 Moving speed m: Mile/hour k: km/hour

PROGRAMMING A CALL SIGN

Program your call sign using a maximum of 9 alphanumeric characters. You may include SSID characters in the string. Unless you program a call sign, you cannot transmit APRS packets.

- 1 Press **[MNU]** to enter Menu mode.
- 2 Press **[↑]/[↓]** to select “MY CALLSIGN (3–1)”, then press **[OK]**.
 - The display for entering a call sign appears; the first digit blinks. The default is “NOCALL”.



- 3 Turn the **Tuning** control to select the first digit.
 - You can enter 0 to 9, A to Z, and –.
- 4 Press **[→]**.
 - The cursor moves to the next digit.
- 5 Repeat steps 3 and 4 to enter up to 9 digits.

BACK	Cancels entry of a call sign.	DEL	Deletes the digit at which the cursor is blinking.
←	Causes the cursor to move backward.	INS	Inserts the currently selected character.
CLR (left BAND SEL)	Clears all digits and backs the cursor to the first digit.		

- 6 Press **[OK]** to complete the setting.

- 7 Press **[MNU]** to exit Menu mode.

The keypad on the MC-53DM also is available to enter alphanumeric characters in step 3. Each press of a Mic key switches entry of characters as below:

1	Q	Z	1		7	P	R	S	7
2	A	B	C	2	8	T	U	V	8
3	D	E	F	3	9	W	X	Y	9
4	G	H	I	4	0	0			
5	J	K	L	5	#	–			
6	M	N	O	6					

Note: To distinguish your various stations or nodes, you can have up to 15 Secondary Station Identifiers (SSIDs); ex. WD6BQD-1 to WD6BQD-15. You always have to put a dash between your call sign and SSID number.







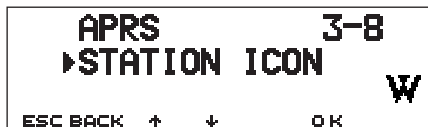







SELECTING YOUR STATION ICON

Select an icon which will be displayed on the monitors of other stations as your ID. You may select an icon depending on your current location.

- 1 Press **[MNU]** to enter Menu mode.
- 2 Press **[↑]/[↓]** to select “STATION ICON (3–8)”, then press **[OK]**.



- 3 Press **[↑]/[↓]** to select from 15 icons plus “OTHERS”, then press **[OK]**.
 - The following 15 icons are selectable:

	KENWOOD		Aircraft		Recreation vehicle
	Home		Boat		Truck
	Portable (tent)		Car		Van
	Yacht		Motorcycle		18 wheeler
	SSTV		Jeep		Digipeater

- 4 Press **[MNU]** to exit Menu mode.

APRS supports approximately 200 icons. It allows users to select each icon by specifying a combination of two ASCII codes, for example, ! and /. One is a symbol code, and the other is a table identification code (either / or \). If you select “OTHERS” in step 3, use the following procedures:

- 4 Press **[↑]/[↓]** to select a symbol code, then press **[OK]**.

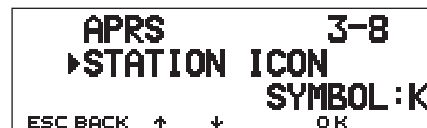

- 5 Press **[↑]/[↓]** to select a table identification code, then press **[OK]**.

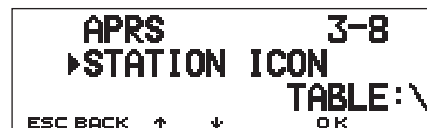

- For icons that can include overlay characters, 0 ~ 9 and A ~ Z are also selectable.

- 6 Press **[MNU]** to exit Menu mode.

Note: Because the icon code table is occasionally revised, download the latest icon code table from Mr. Bruninga's Web page (<http://web.usna.navy.mil/~bruninga/aprs.html>). Click on “DOWNLOAD APRS” on its home page, then download APRSnnn.zip from the FTP directory where nnn is a 3-digit number. After uncompressing the zip file, you will find a created README directory. Open and see Symbols.txt under this directory.

PROGRAMMING POSITION DATA

This transceiver has 5 memory channels for storing position data. Program latitude and longitude data for up to 5 locations from which you will often transmit APRS packets. You can also name the 5 memory channels.

Note: Grid squares were developed to shortly identify locations anywhere on the Earth. The world is first divided into 324 areas (AA ~ RR) called "fields". Each field is then divided into 100 "squares" (00 ~ 99). Each square is further divided into 576 "sub-squares" (AA ~ XX). The world is thus divided into 18,662,400 grids; each grid is expressed with 6 digits.

- 1 Press **[MNU]** to enter Menu mode.
 - You may press **[F] (1 s)**, **[POS]** instead to skip step 2.
- 2 Press **[↑]/[↓]** to select "MY POSITION (3-4)", then press **[OK]**.
- 3 Press **[↑]/[↓]** to select from channels 1 to 5, then press **[OK]**.
 - If you intend to use the current channel after exiting Menu mode, press **[USE]** before pressing **[OK]**. An asterisk appears at the left of the channel number.
 - The display for entering a memory name appears; the first digit blinks.

```

abc
123 ▶MY POSITION 3-4
CHAR * 1: ▶■■■■■■■■■■
N 00°00.00'
W 000°00.00' GS:JJ00AA
BACK DEL ← → INS OK CLR
    
```

Grid square locator

- To skip naming the channel, press **[OK]** again. You can jump to step 7.

- 4 Turn the **Tuning** control to select the first digit.
 - You can enter alphanumeric characters plus special ASCII characters.
- 5 Press **[→]**.
 - The cursor moves to the next digit.
- 6 Repeat steps 4 and 5 to enter up to 8 digits, then press **[OK]**.

CHAR	Switches among the sets of alphanumeric characters, accented letters (TM-D700E only), and special ASCII characters.		
A/a	Switches between small and capital letters.	BACK	Cancels Memory Name Entry.
DEL	Deletes the digit at which the cursor is blinking.	←	Causes the cursor to move backward.
INS	Inserts the currently selected character.	CLR (left BAND SEL)	Clears all digits and backs the cursor to the first digit.

- 7 Press **[↑]/[↓]** to switch between north latitude (default) and south latitude, then press **[OK]**.
 - The degree digits blink.
- 8 Press **[↑]/[↓]** to select data for degrees, then press **[OK]**.
 - The minute digits blink.
- 9 Repeat step 8 to select data for minutes (down to one hundredth digit).

```

▶MY POSITION 3-4
* 1: KENWOOD
N 33°50.38'
W 000°00.00' GS:JM03AU
ESC BACK ↑ ↓ OK
    
```

- 10 Press [**↑**]/[**↓**] to switch between west longitude (default) and east longitude, then press [**OK**].
- The degree digits blink.
- 11 Press [**↑**]/[**↓**] to select data for degrees, then press [**OK**].
- The minute digits blink.
- 12 Repeat step 11 to select data for minutes (down to one hundredth digit).

```

▶MY POSITION 3-4
* 1: KENWOOD
N 33° 50.38"
▶W 118° 13.80"    GS:DM03UJ
ESC BACK  ↑  ↓    OK
  
```

- 13 As necessary, repeat steps 2 to 12 to store in up to 5 memory channels.
- 14 Press [**MNU**] to exit Menu mode.

The keypad on the MC-53DM also is available to enter alphanumeric characters in step 4. See page ii.

To select and set from up to 5 programmed channels, repeat steps 1 to 3. In step 3 press [**↑**]/[**↓**] to select the desired channel, then press [**USE**].

Note:

- ◆ If you have selected "NMEA" or "NMEA96" in Menu 3–2, pressing [**F**] (1 s), [**POS**] does not allow you to access the display for entering position data. The position data received via the GPS receiver most lately will be displayed. Pressing [**TIME SET**] resets the internal clock to the time input from the GPS receiver.
- ◆ If using a GPS receiver, you can also copy the measured data to the position entry display for Menu 3–4. Press [**F**] (1 s), [**POS**] to display the measured data, then press [**COPY**]. A message which asks the channel number appears. Press [**↑**]/[**↓**] to select the channel number, then press [**OK**].

SELECTING A POSITION COMMENT

The APRS data which you transmit always includes one of the 15 predetermined position comments. Select an appropriate comment depending on your situation.

- 1 Press [**MNU**] to enter Menu mode.
- 2 Press [**↑**]/[**↓**] to select "POSITION COMMENT (3–6)", then press [**OK**].

```

APRS          3-6
▶POSITION COMMENT
Off Duty
ESC BACK  ↑  ↓    OK
  
```

- 3 Press [**↑**]/[**↓**] to select the desired comment.
- 4 Press [**OK**] to complete the setting.
 - If you select "Emergency!", a confirmation message appears. Press [**OK**] again.
- 5 Press [**MNU**] to exit Menu mode.

The selectable comments are listed below:

Off Duty (default)	En Route	In Service
Returning	Committed	Special ¹
Priority ¹	Emergency! ²	Custom 0 ~ 6

- ¹ Selecting these comments will highlight your station on all other APRS computer displays.
- ² Select this comment only when absolutely necessary. You will activate alarms in all monitoring APRS stations.

Note: Custom 0 ~ 6 selectable in Menu 3–6 are not defined; these are reserved for personal definition.

STORING STATUS TEXT

Status text is another comment to transmit with position data. Unlike a position comment, you can make any desired comment using a maximum of 28 alphanumeric characters. This transceiver has 5 memory channels for preprogramming.

Note: Attaching a long comment can double the size and length of the packet. Transmit a comment only if necessary.

- 1 Press **[MNU]** to enter Menu mode.
- 2 Press **[↑]/[↓]** to select “STATUS TEXT (3–9)”, then press **[OK]**.



- 3 Press **[↑]/[↓]** to select from channels 1 to 5, then press **[OK]**.
 - If you intend to use the current channel after exiting Menu mode, press **[USE]** before pressing **[OK]**. An asterisk appears at the left of the channel number.
 - The display for entering status text appears; the first digit blinks.



- 4 Turn the **Tuning** control to select the first digit.
 - You can enter alphanumeric characters plus special ASCII characters.
- 5 Press **[→]**.
 - The cursor moves to the next digit.
- 6 Repeat steps 4 and 5 to enter up to 28 digits, then press **[OK]**.

CHAR	Switches between the sets of alphanumeric characters and special ASCII characters.		
A/a	Switches between small and capital letters.	BACK	Cancels Status Text Entry.
DEL	Deletes the digit at which the cursor is blinking.	←	Causes the cursor to move backward.
INS	Inserts the currently selected character.	CLR (left BAND SEL)	Clears all digits and backs the cursor to the first digit.

- 7 As necessary, repeat steps 2 to 6 to store in up to 5 memory channels.
- 8 Press **[MNU]** to exit Menu mode.

The keypad on the MC-53DM also is available to enter alphanumeric characters in step 4. See page ii.

To select and set from up to 5 programmed channels, repeat steps 1 to 3. In step 3 press **[↑]/[↓]** to select the desired channel, then press **[USE]**.

PROGRAMMING A GROUP CODE

Using a group code relieves you from receiving unwanted packets. The APRS on this transceiver supports the following three types of group codes.

All calls:

Program a 6-digit code that always starts with AP. You will receive all APRS packets which include AP in group codes. It does not matter whether or not the subsequent 4 digits match. The default on this transceiver is APK101.

Note: APRS packets, which are generated via various methods, include various codes instead of group codes. Using “All calls” allows you to receive packets which include the following codes:

GPS	SYM	QST	CQ	BEACON
ALL	SKYWRN	MAIL	ID	SPCL

Special:

Enter “SPCL”. You will receive only APRS packets that include SPCL as a group code. This code is generally programmed by all stations at a special event.

Alternate net:

Program any other code with a maximum of 6 digits. You will receive only APRS packets that include the exact same code. In order to reject other packets, this code should not include characters specified by the above two types.

Note: Menu 3–E allows you to enter up to 9 digits (not just 6 digits) because of possible future enhancement of the group code system.

- 1 Press **[MNU]** to enter Menu mode.
- 2 Press **[↑]/ [↓]** to select “UNPROTOCOL (3–E)”, then press **[OK]**.
 - The display for entering a group code appears; the first digit blinks. The default is APK101 (All calls).



- 3 Turn the **Tuning** control to select a character.
 - You can enter 0 to 9, A to Z, and –.
- 4 Press **[→]**.
 - The cursor moves to the next digit.
- 5 Repeat steps 3 and 4 to enter up to 9 digits.

BACK	Cancels entry of a group code.	DEL	Deletes the digit at which the cursor is blinking.
←	Causes the cursor to move backward.	INS	Inserts the currently selected character.
CLR (left BAND SEL)	Clears all digits and backs the cursor to the first digit.		

- 6 Press **[OK]** to complete the setting.
- 7 Press **[MNU]** to exit Menu mode.

The keypad on the MC-53DM also is available to enter alphanumeric characters in step 3. See page ii.

PROGRAMMING A PACKET PATH

Program a packet path to specify how APRS data should be transferred via one or more repeaters. For further description, refer to “PACKET PATH AND DIGIPEATER” {page 9}. The default is “RELAY,WIDE” that is one of the common settings.

- 1 Press **[MNU]** to enter Menu mode.
- 2 Press **[↑]/[↓]** to select “PACKET PATH (3–B)”, then press **[OK]**.
 - The display for entering a packet path appears; the first digit blinks.



- 3 Turn the **Tuning** control to select a character.
 - You can enter 0 to 9, A to Z, , (comma), and –.
- 4 Press **[→]**.
 - The cursor moves to the next digit.
- 5 Repeat steps 3 and 4 to enter up to 79 digits.
 - You can enter up to 8 path segments in sequence; each segment must have less than 10 characters. Use a comma to separate each segment.

,	Inserts a comma.	BACK	Cancels entry of a packet path.
DEL	Deletes the digit at which the cursor is blinking.	←	Causes the cursor to move backward.
INS	Inserts the currently selected character.	CLR (left BAND SEL)	Clears all digits and backs the cursor to the first digit.

- 6 Press **[OK]** to complete the setting.
- 7 Press **[MNU]** to exit Menu mode.

The keypad on the MC-53DM also is available to enter alphanumeric characters in step 3. Each press of a Mic key switches entry of characters as below:

1	Q	Z	1		7	P	R	S	7
2	A	B	C	2	8	T	U	V	8
3	D	E	F	3	9	W	X	Y	9
4	G	H	I	4	0	0			
5	J	K	L	5	#	–	,		
6	M	N	O	6					

Downloaded by
RadioAmateur.EU

4

Let us describe five basic methods for editing a packet path. Methods 3 to 5 are supported only by advanced APRS networks.

Method 1 (Specific Path):

Program the call signs of one or more digipeaters in the sequence of transfer relay; ex. "KD6ZZV,KF6RJZ".

Method 2 (Generic Path):

Program RELAY and/or WIDE; ex. "RELAY,WIDE" (or simply "R,W"). In this example, your APRS packet is transferred to any RELAY digipeater near your position first, then to any WIDE digipeater. You can also program more than one WIDE. If you enter "WIDE,WIDE" for example, your APRS packet will be transferred to any WIDE near your position first, then to another WIDE.

Method 3 (WIDEN-N Path):

Program WIDEN-N, where both Ns indicate the number of WIDE digipeaters to be used for relay. If you enter "WIDE3-3" (or simply W3) for example, your APRS packet will be relayed by three WIDEs in any direction.

Method 4 (TRACEN-N Path):

The operation is the same as WIDEN-N except that digipeaters add their call signs to your packet before forwarding. You may program "TRACE3-3" (or simply T3) for example.

Method 5 (SSID Path):

Program a single number 1 to 15. You can easily specify the number of digipeaters that will be used for relay. You can also specify which directions of digipeaters relative to your position will be used. See the table.

Parameter	Number of digipeaters	Direction
1	1	All
2	2	All
3	3	All
4	4	All
5	5	All
6	6	All
7	7	All
8	2 (or more) ¹	North
9	2 (or more) ¹	South
10	2 (or more) ¹	East
11	2 (or more) ¹	West
12	Many ²	North
13	Many ²	South
14	Many ²	East
15	Many ²	West

¹ The first digipeater which receives your APRS data specifies the entire route to the destination before forwarding; often 2 digipeaters are used in total.

² The digipeater which receives your APRS data specifies the call sign of the next digipeater before forwarding. This is repeated until your APRS data reaches the destination.

SELECTING PACKET TRANSMIT METHOD

Select the operation method for transmitting APRS packets. The table concludes how operations differ depending on the selection. Access Menu 3–C (PACKET TX) and select Manual (default), PTT, or Auto.



MANUAL	Each press of [F] (1 s), [BCON] transmits your APRS packet.
PTT	<ol style="list-style-type: none"> 1 Press [F] (1 s), [BCON] to switch the function ON. <ul style="list-style-type: none"> • “BCON” appears and blinks. 2 Press and hold Mic [PTT], then speak into the microphone. 3 Release Mic [PTT]. <ul style="list-style-type: none"> • Releasing the switch transmits your APRS packet. • You cannot retransmit an APRS packet unless the time selected in Menu 3–D (TX INTERVAL) passes. Wait until “BCON” starts blinking to indicate transmitting is ready. 4 To switch the function OFF, press [F] (1 s), [BCON] again.
AUTO	<ol style="list-style-type: none"> 1 Press [F] (1 s), [BCON] to switch the function ON. <ul style="list-style-type: none"> • “BCON” appears. • Switching the function ON transmits your APRS packet once. After that, APRS packets are automatically transmitted at intervals of the period selected in Menu 3–D (TX INTERVAL). 2 To switch the function OFF, press [F] (1 s), [BCON] again.

SELECTING PACKET TRANSMIT INTERVAL

You can change the interval for automatically transmitting APRS packets. Access Menu 3–D (TX INTERVAL) and select 0.2, 0.5, 1, 2, 3, 5, 10, 20, or 30 minutes. The default is 3 minutes.



Note:

- ◆ With “AUTO” in Menu 3–C and Beacon ON, pressing [OK] to complete the setting causes the APRS packet to be immediately transmitted. After that, APRS packets are transmitted at intervals of the selected period.
- ◆ While signals are present, an APRS packet is not transmitted after the interval. Approximately 2 seconds after signals drop, transmitting is executed.

SELECTING STATUS TEXT TRANSMIT RATE

A long status text string can double the size and length of the APRS packet. Access Menu 3–A and specify how frequently status text is included in APRS packets to be transmitted. The selectable range is 1/1 to 1/8 and OFF (default). If you select 1/3 for example, status text is included in your packets once every 3 times; accordingly stations who receive your packets will see your status text once every 3 times.

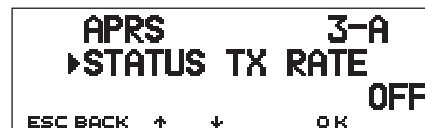

RESTRICTING RECEPTION OF APRS DATA

If APRS is popular in your area, you may receive too many APRS packets for a short period. If this disturbs your APRS activities, specify a distance from your location. You will not receive APRS packets from stations beyond this distance.

Access Menu 3-7 (POSITION LIMIT) and select the range from 10 to 2500 in steps of 10, plus OFF (default). The unit is mile or kilometer depending on the selection in Menu 3-G (MILE/KILOMETER) {page 16}.

4



PROGRAMMING POSITION AMBIGUITY

There may be cases where you do not know or do not want to report your precise locations. For position data, you can select the number of digits not to be included in your packets. Access Menu 3-5 (POS AMBIGUITY) and select 1 to 4, or OFF (default). The table shows how the digits are cleared.



OFF	1	2	3	4
33° 50.38	33° 50.3	33° 50.	33° 5 .	33° .
118° 13.80	118° 13.8	118° 13.	118° 1 .	118° .

PACKET MONITOR DISPLAY

This transceiver presents Terminal Window mode to display raw data of received APRS packets. It displays up to 155 characters per page and holds up to 10 pages.

- 1 Press **[F]** (1 s), **[P.MON]** to enter Terminal Window mode.

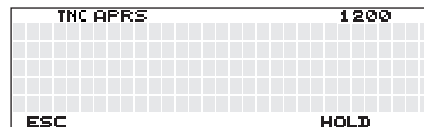

- 2 To access old pages, press **[HOLD]**.
 - Press **[↑]**/**[↓]** to change the page.
 - Press **[RESUME]** to quit the Hold function.
 - While using the Hold function, newly received packets will not be stored in buffer.

Note:

- ◆ The terminal window is not available for sending a command to the TNC.
- ◆ The terminal window is available in APRS mode (not in Packet mode).
- ◆ The data in buffer is cleared when the transceiver power is turned OFF.

SETTING AS A DIGIPEATER

This transceiver with a built-in TNC may also be used as a digipeater. As described in “PACKET PATH AND DIGIPEATER” {page 9}, a volunteer who installs a digipeater is supposed to program it either as a RELAY or WIDE depending on various conditions.

Note: This transceiver is capable of setting up to 4 path segments (aliases); each path segment must have less than 10 characters. However, it is common to program either “RELAY” or “WIDE” as mentioned above.

- 1 Press [MNU] to enter Menu mode.
- 2 Press [↑]/[↓] to select “DIGIPEATER (3-K)”, then press [OK].



- 3 Press [↑]/[↓] to switch the function ON, then press [OK].
- 4 Press [↑]/[↓] to select “UIDIGI (3-L)”, then press [OK].
 - The display for entering a path appears; the first digit blinks.



- 5 Turn the **Tuning** control to select a character.
 - You can enter 0 to 9, A to Z, , (comma), and –.
- 6 Press [→].
 - The cursor moves to the next digit.
- 7 Repeat steps 5 and 6 to enter up to 39 digits.

	Inserts a comma.	BACK	Cancels entry of a path.
DEL	Deletes the digit at which the cursor is blinking.	←	Causes the cursor to move backward.
INS	Inserts the currently selected character.	CLR (left BAND SEL)	Clears all digits and backs the cursor to the first digit.

4

- 8 Press [OK] to complete the setting.
- 9 Press [MNU] to exit Menu mode.

The keypad on the MC-53DM also is available to enter alphanumeric characters in step 5. Each press of a Mic key switches entry of characters as below:

1	Q	Z	1		7	P	R	S	7
2	A	B	C	2	8	T	U	V	8
3	D	E	F	3	9	W	X	Y	9
4	G	H	I	4	0	0			
5	J	K	L	5	#	–	,		
6	M	N	O	6					

APRS[®] MESSAGE

The APRS[®] supports a function for sending a message or bulletin independent of position reports. You can send a message to a single station only or a bulletin to all other stations. You may use a group code to exchange messages among members in your group or to reject unwanted bulletins.

Each message which you transmit can consist of up to 64 alphanumeric characters. A maximum of 16 incoming or outgoing messages can be held in the message memory.

5

OPERATION FLOW

The following steps should guide you to a good start of APRS Message operation.

1 Access Menu 3-I to select band A or B as the data band {page 13}. The default is band A.

2 Press **[F] (1 s)**, **[TNC]** to enter APRS mode.

- “**TNC APRS**” should appear.

3 On the data band, select the same frequency as other stations in your group.

- You may tune to the frequency of an appropriate digipeater network (144.390 MHz in the U.S.) {page 9}.

4 Access Menu 3-1 to program your call sign (9 digits max.) {page 17}.

Now you are ready to receive a message from other stations. Refer to “RECEIVING A MESSAGE” {page 29}. To transmit a message, proceed to step 5.

5 Enter a message (or bulletin) using up to 64 alphanumeric characters {page 30}.

6 If you want, access Menu 3-P (for messages) or Menu 3-O (for bulletins) to program group codes {page 34}.

7 Access Menu 3-C to select the operation method for transmitting {page 25}.

The method for transmitting differs depending on the selection in Menu 3-C. See page 32.

When you send a message (not a bulletin), a reception acknowledgment should be returned; “ack0 ~ 9 (or A ~ Z)” appears. If your message is rejected by the recipient, “rej0 ~ 9 (or A ~ Z)” appears.

Note: When using an optional VS-3 unit, you may select “APRS ONLY” in Menu 1-2-4 (VOICE). Each time you receive a message addressed to you, the transceiver announces the call sign of the sender. If the initial character of the message is %, the transceiver announces the subsequent characters one by one.

RECEIVING A MESSAGE

Each time a proper message is received, the frequency display is interrupted to show information as below:

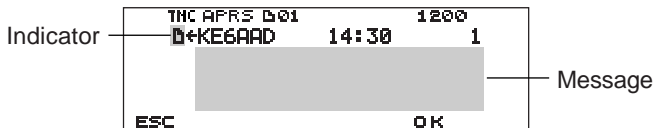

- The display shows up to 64 characters of the message.
- “01” will appear to indicate the number of messages not yet read.
- The following indicators appear depending on the types of received messages:

01	Message addressed to you
B	Bulletin
!	Report by the National Weather Service
*	Reception acknowledgment (or rejection) to your message

To restore the frequency display after reading the message, press **[OK]**. “01” will disappear. If you do not read the message at this time, press **[ESC]**. “01” will remain on the restored frequency display.

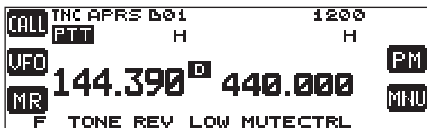

- The number increments if you press **[ESC]** for newly received messages. Checking them with the List function {page 31} causes the number to decrement. If “01” was shown, both the number and message icon disappear.

When a duplicate message from the same station is received, an error beep sounds; however, an acknowledgment is returned. “dM” and a call sign appear on the display.



- When a message to other stations is received, “oM” appears.

This transceiver beeps each time it receives any type of APRS packet. You may access Menu 3–F (BEEP) to change this setting. The default is “ALL”.

Selections	New Packet	Duplicate Packet	Invalid Packet
OFF	No beep	No beep	No beep
MINE	Beeps only when receiving a message addressed to you.		
ALL NEW	Beep	No beep	No beep
ALL	Beep	Beep	Beep

Note:

- ◆ This transceiver allows you to receive a message also when the SSID does not match. However, it will not return a reception acknowledgment.
- ◆ The dedicated memory is used for storing both incoming and outgoing messages. Receiving a new message when the memory is full causes the oldest message to be deleted. A message not yet transmitted 5 times may be unexpectedly deleted. If the oldest message has not been accessed using the List function when memory is full, a new message does not replace the oldest message. This transceiver will return a reject command and display “rM”.

ENTERING A MESSAGE

To transmit a message, first enter the call sign of the target station. To transmit a bulletin, enter "BLN#" instead; where # must be 0 to 9 or A to Z. When the length of your bulletin exceeds 64 digits, you may transmit more than one packet to send the entire bulletin. Use # to indicate the sequence of the bulletin portions. For example, enter "BLN0" (or "BLNA") to send the first packet, then "BLN1" (or "BLNB") to send the second packet.

- 1 Press **[F]** (1 s), **[MSG]**.
- 2 Press **[↑]/[↓]** to select "INPUT", then press **[OK]**.
 - The display for entering a call sign appears; the first digit blinks.

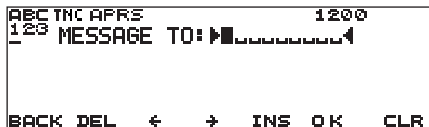

- 3 Turn the **Tuning** control to select the first digit.
 - You can enter 0 to 9, A to Z, and –.
- 4 Press **[→]**.
 - The cursor moves to the next digit.
- 5 Repeat steps 3 and 4 to enter up to 9 digits.

BACK	Cancels entry of a call sign.	DEL	Deletes the digit at which the cursor is blinking.
←	Causes the cursor to move backward.	INS	Inserts the currently selected character.
CLR (left BAND SEL)	Clears all digits and backs the cursor to the first digit.		

- 6 Press **[OK]** to complete the setting.
 - The display for entering a message appears; the first digit blinks.

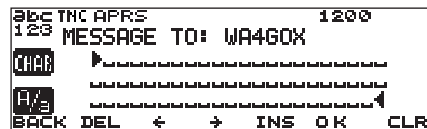

- 7 Turn the **Tuning** control to select the first digit.
 - You can enter alphanumeric characters plus special ASCII characters.
- 8 Press **[→]**.
 - The cursor moves to the next digit.
- 9 Repeat steps 7 and 8 to enter up to 64 digits.

CHAR	Switches between the sets of alphanumeric characters and special ASCII characters.		
A/a	Switches between small and capital letters.	BACK	Cancels Message (or Bulletin) Entry.
DEL	Deletes the digit at which the cursor is blinking.	←	Causes the cursor to move backward.
INS	Inserts the currently selected character.	CLR (left BAND SEL)	Clears all digits and backs the cursor to the first digit.

- 10 Press **[OK]** to complete the setting.

The keypad on the MC-53DM also is available to enter alphanumeric characters in steps 3 and 7. See page ii.

ACCESSING RECEIVED APRS MESSAGES

This transceiver is capable of storing a maximum of 16 messages in memory. You can easily access one of those.

- 1 Press **[F] (1 s)**, **[MSG]**.
- 2 Press **[↑]/[↓]** to select “LIST”, then press **[OK]**.

```

THC APRS 1200
▶ 1: B+WD6BQD-1 15:34 4
  2: B+KE6AAD 15:11
  3: B+KD6ZZU 13:02*
  4: B+KF6RJZ-3 14:24
  5: B+KJ6HC 14:25(3)
BACK DEL ↑ ↓ MSG OK POS
    
```

- The newer message the smaller number assigned; the latest message is assigned 1.

BACK	Quits Message List Display.	DEL	Deletes the current message.
↑	Moves the cursor upward.	↓	Moves the cursor downward
MSG	Allows message entry to the current station {page 30}.	POS (left BAND SEL)	Displays the latest position data of the current station, if stored in memory.

- 3 Press **[↑]/[↓]** to select the desired message using the cursor (▶).
- 4 Press **[OK]**.

If you select an incoming message, the following display appears:

```

THC APRS 1200
▶ 4: B+KF6RJZ-3 14:24 3
I will come tomorrow.
What time do you think
convenient?
BACK DEL ↑ ↓ MSG POS
    
```

BACK	Restores the list of messages.	DEL	Deletes the current message.
↑	Displays the previous message.	↓	Displays the subsequent message.
MSG	Allows message entry to the current station {page 30}.	POS (left BAND SEL)	Displays the latest position data of the current station, if stored in memory.

5

If you select one of your outgoing messages, the following display appears:

```

THC APRS 1200
▶ 5: B+KJ6HC 14:25(3) 5
I'm free this afternoon
n. Shall we meet somew
here?
BACK DEL ↑ ↓ MSG RE-TX CANCEL
    
```

BACK	Restores the list of messages.	DEL	Deletes the current message.
↑	Displays the previous message.	↓	Displays the subsequent message.
MSG	Allows message entry to the current station {page 30}.	RE-TX	When pressed for a message assigned a period (.) {page 32}, resets the retry counter to 5 more transmissions.
CANCEL (left BAND SEL)	Cancels further transmissions of the current message. A period (.) is assigned to the message {page 32}.		

The table below shows the meanings of the symbols to be shown in step 2.

1	2		3
<pre> TNC APRS ▶ 1: B*WD6BQD-1 15:34 1200 2: B*KE6AAD 15:11 3: B*KD6ZJU 13:02* 4: B*KF6RTJ-3 14:24 5: B*KJ6HC 14:25(3) BACK DEL ↑ ↓ MSG OK POS </pre>			

Not-yet-read indicator

Time
(message received)

Sequence

1 Message Type

	Message addressed to you
B	Bulletin
!	Report by the National Weather Service

2 RX or TX?

←	Received message (or bulletin)
→ ¹	A message (or bulletin) for transmitting

3 Status

(n) ¹	"n" indicates the remaining number of times for transmitting the message (or bulletin).
* ¹	A message for which a reception acknowledgment was returned
. ¹	A message (or bulletin) transmitted 5 times (For a message, a reception acknowledgment was not returned.)

¹ These indicators appear for outgoing messages (or bulletins).

TRANSMITTING A MESSAGE

Select the operation method for transmitting APRS messages (or bulletins). Access Menu 3–C (PACKET TX) and select Manual (default), PTT, or Auto. This selection is shared with the method for transmitting position data {page 25}. The table concludes how operations differ depending on the selection. For an APRS message, there is no difference in the transmitting methods between Manual and PTT selections.

MANUAL or PTT	1 Press [F] (1 s), [MSG] .
	2 Press [↑] / [↓] to select "TRANSMIT", then press [OK] .
AUTO	<p>Pressing [OK] after selecting "AUTO" transmits your APRS message (or bulletin) once. After that, it is automatically transmitted at intervals of one minute.</p> <ul style="list-style-type: none"> With a message entered, the transceiver repeats transmitting up to 5 times until a reception acknowledgment is returned. For a bulletin, it always repeat transmitting 5 times; a reception acknowledgment is not returned.

AUTO ANSWER REPLY

While you are driving, for example, you cannot immediately answer to received messages. On this transceiver, you can program the message to be automatically returned when a message is received.

- 1 Press **[MNU]** to enter Menu mode.
- 2 Press **[↑]/[↓]** to select “AUTO MSG REPLY (3-M)”, then press **[OK]**.



- 3 Press **[↑]/[↓]** to select “ON”, then press **[OK]**.
- 4 Press **[↑]/[↓]** to select “REPLY MSG (3-N)”, then press **[OK]**.
 - The display for entering a message appears; the first digit blinks.



- 5 Turn the **Tuning** control to select the first digit.
 - You can enter alphanumeric characters plus special ASCII characters.

- 6 Press **[→]**.
 - The cursor moves to the next digit.
- 7 Repeat steps 5 and 6 to enter up to 64 digits.

CHAR	Switches between the sets of alphanumeric characters and special ASCII characters.		
A/a	Switches between small and capital letters.	BACK	Cancels Message Entry.
DEL	Deletes the digit at which the cursor is blinking.	←	Causes the cursor to move backward.
INS	Inserts the currently selected character.	CLR (left BAND SEL)	Clears all digits and backs the cursor to the first digit.

5

- 8 Press **[OK]** to complete the setting.
- 9 Press **[MNU]** to exit Menu mode.

The keypad on the MC-53DM also is available to enter alphanumeric characters in step 5. Each press of a Mic key switches entry of characters as below:

1	q	z	1	Q	Z			6	m	n	o	6	M	N	O	
2	a	b	c	2	A	B	C	7	p	r	s	7	P	R	S	
3	d	e	f	3	D	E	F	8	t	u	v	8	T	U	V	
4	g	h	i	4	G	H	I	9	w	x	y	9	W	X	Y	
5	j	k	l	5	J	K	L	0	Space	0						
#	?	!	'	.	,	-	/	&	#	%	()	<	>	;	:
	"	@														

PROGRAMMING A GROUP CODE

Use a message group code to exchange messages only among your group members. With one or more message group codes programmed, you will receive messages that include the same group code(s), besides messages addressed to you. If you program one or more bulletin group codes, you will not receive bulletins addressed to other specific groups. You can program any desired code using alphanumeric characters; up to 9 characters for messages, and up to 4 characters for bulletins. You can also program up to 6 codes at the same time; each code must be separated by a comma (,). If you program 3 message group codes, for example, you will receive all messages that include one of the 3 codes. If you program 3 bulletin group codes, you will reject bulletins addressed to specific groups which do not use any of the 3 codes.

5

- 1 Press **[MNU]** to enter Menu mode.
- 2 Press **[↑]/[↓]** to select “MSG GROUP (3–P)” or “BLN GROUP (3–O)”, then press **[OK]**.
 - The display for entering one or more group codes appears; the first digit blinks.



- 3 Turn the **Tuning** control to select the first digit.
 - You can enter 0 to 9, A to Z, , (comma), and –. For messages, “*” is also selectable.

- 4 Press **[→]**.
 - The cursor moves to the next digit.
- 5 Repeat steps 3 and 4 to enter up to 6 codes.

[,]	Inserts a comma.	BACK	Cancels entry of a group code.
DEL	Deletes the digit at which the cursor is blinking.	←	Causes the cursor to move backward.
INS	Inserts the currently selected character.	CLR (left BAND SEL)	Clears all digits and backs the cursor to the first digit.

- 6 Press **[OK]** to complete the setting.
- 7 Press **[MNU]** to exit Menu mode.

The keypad on the MC-53DM also is available to enter alphanumeric characters in step 3. See page ii.

In order to include a message group code in your outgoing packet, enter a group code in place of a call sign {page 30}. To include a bulletin group code, enter it following BLN# {page 30}; for example, “BLN#ABC” where ABC is a group code. Use up to 9 characters for a message group code or up to 4 characters for a bulletin group code.

Note: Unlike a message, a bulletin including a group code will be received by stations who do not program any bulletin group code.

SLOW-SCAN TELEVISION (SSTV) WITH VC-H1

Slow-scan Television (SSTV) is a popular application for transmitting still images over the air from one station to another. The VC-H1 is an optional portable unit which includes all requirements for SSTV; a slow-scan converter, a CCD camera, and an LCD monitor. You can transmit or receive full-color images just by connecting the VC-H1 to this transceiver. For further information on the VC-H1, see the instruction manual for the VC-H1.

From this transceiver you can enter and superimpose a message, an RSV report, and a call sign onto an image on the VC-H1 monitor. You can also select colors for those information.

CONNECTION WITH VC-H1

In order to use the full functions supported by this transceiver, you need to prepare two cables by yourself. You may use a commercially available female DB-9 connector, an optional PG-5A cable equipped with a 6-pin mini DIN plug, and an optional connector kit (E59-0407-XX) which mates with the VC-H1 DATA port; one end of the PG-5A cable has not been connectorized.

Note:

- ◆ Switch OFF both the transceiver and VC-H1 before making the connection.
- ◆ An optional PG-4T cable mates with both the DATA connector on this transceiver and the DATA port on the VC-H1. This cable alone, however, allows only image transfer from/ to other stations.
- ◆ The VC-H1 functions as a speaker microphone only when connected with a handy transceiver.

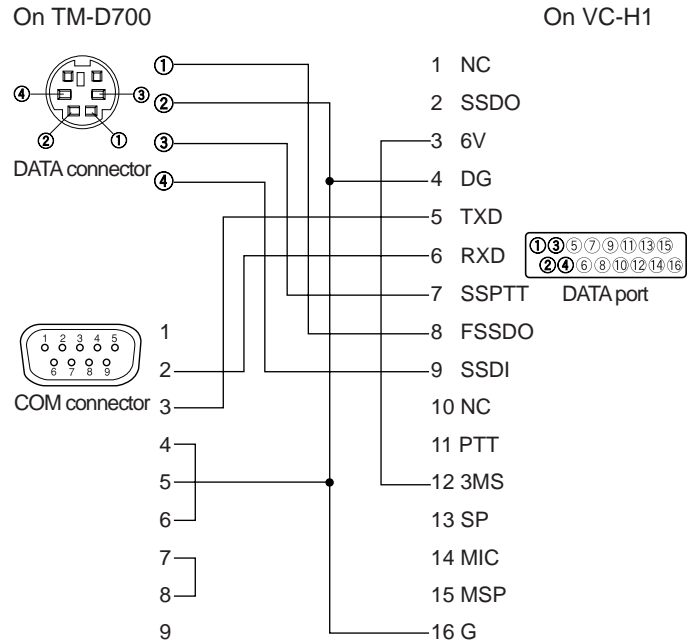

Downloaded by RadioAmateur.EU

ENTERING CALL SIGN/ MESSAGE/ RSV

Use the following procedures to enter a call sign, a message, or an RSV report. RSV stands for readability, signal strength, and video. If you receive a clear image free from noise, the RSV report should be 595.

Note: The only difference among Menus 2-1, 2-3, and 2-5 is the maximum number of digits that you can enter. So you may enter another message using Menu 2-5, for example.

- 1 Press **[MNU]** to enter Menu mode.
- 2 Press **[↑]/[↓]** to select “MY CALL (2-1)”, “MESSAGE (2-3)”, or “RSV (2-5)”, then press **[OK]**.
 - The display for entering characters appears; the first digit blinks.

6

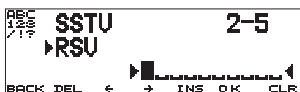

- 3 Turn the **Tuning** control to select a character.
 - You can enter 0 to 9, A to Z, -, /, !, and ?.
- 4 Press **[→]**.
 - The cursor moves to the next digit.
- 5 Repeat steps 3 and 4 to enter up to 8 digits (call sign), 9 digits (message), or 10 digits (RSV report).

BACK	Cancels Call Sign, Message, or RSV Entry.	DEL	Deletes the digit at which the cursor is blinking.
←	Causes the cursor to move backward.	INS	Inserts the currently selected character.
CLR (left BAND SEL)	Clears all digits and backs the cursor to the first digit.		

- 6 Press **[OK]** to complete the setting.
- 7 Press **[MNU]** to exit Menu mode.

The keypad on the MC-53DM also is available to enter alphanumeric characters in step 3. See page ii.

Readability		Video	
1	Unreadable	1	Unrecognizable
2	Barely readable	2	Barely recognizable
3	Readable with considerable difficulty	3	Recognizable with considerable difficulty
4	Readable with practically no difficulty	4	Recognizable with practically no difficulty
5	Perfectly readable	5	Perfectly recognizable
Signal Strength			
1	Faint signals barely perceptible	6	Good signals
2	Very weak signals	7	Moderately strong signals
3	Weak signals	8	Strong signals
4	Fair signals	9	Extremely strong signals
5	Fairly good signals		

SELECTING COLOR FOR CALL SIGN/ MESSAGE/ RSV

You can select white (default), black, blue, red, magenta, green, cyan, or yellow to color the call sign, message, or RSV report.

- 1 Press **[MNU]** to enter Menu mode.
- 2 Press **[↑]/ [↓]** to select “MY CALL COLOR (2-2)”, “MESSAGE COLOR (2-4)”, or “RSV COLOR (2-6)”, then press **[OK]**.



- 3 Press **[↑]/ [↓]** to select the color.
- 4 Press **[OK]** to complete the setting.
- 5 Press **[MNU]** to exit Menu mode.

EXECUTING SUPERIMPOSITION

After connecting the VC-H1 to this transceiver, use the following procedure to execute superimposition. First recall the desired image on the VC-H1.

- 1 Press **[MNU]** to enter Menu mode.
- 2 Press **[↑]/ [↓]** to select “2-7 (SUPERIMPOSE)”, then press **[OK]**



- “EXECUTING” appears and data transfer starts.

- 3 Press **[MNU]** to exit Menu mode.

Note: Switch OFF both the transceiver and VC-H1 before making the connection.

SSTV MODE CHANGE

You can also change the SSTV mode set on the VC-H1, from this transceiver. First connect the transceiver to the VC-H1, and switch ON both the transceiver and VC-H1. The selectable SSTV modes are as follows:

Robot (color) 36	Robot (color) 72	AVT 90
AVT 94	Scottie S1	Scottie S2
Martin M1	Martin M2	Fast FM

- 1 Press **[MNU]** to enter Menu mode.
- 2 Press **[↑]/[↓]** to select Menu 2–8 (TX MODE), then press **[OK]**.
 - The SSTV mode currently set on the VC-H1 appears.
- 3 Press **[↑]/[↓]** to select the desired mode.
- 4 Press **[OK]** to change the setting.
- 5 Press **[MNU]** to exit Menu mode.

Note: When using Fast FM, switch OFF the Tone, CTCSS, or DCS function.

VC-H1 CONTROL

If you have another transceiver that has the Tone function, you can use it as a remote control for the VC-H1. Transmit a subaudible tone from the remote control to this transceiver connected with the VC-H1 for more than 1 second. Then this transceiver causes the VC-H1 to capture an image, executes the superimposition, and transmits the image to the target station. You must select the same tone frequency on both transceivers; on this transceiver, program a CTCSS frequency; see page 55 on the other manual (main).

Access Menu select 2–9 (VC SHUTTER) and select “ON”.



- Switching the function ON activates the CTCSS; “CT” appears.

The following table concludes the settings you must confirm:

TM-D700 and remote control	The current frequency is the same as the target station.
TM-D700 and remote control	The tone frequencies match ¹ .
Remote control	The Tone function is ON.
VC-H1	The power is ON ² .

¹ For the TM-D700, program a matching CTCSS frequency.

² The camera and LCD monitor must not be left ON.

Note:

- ◆ If you have made no entry for superimposition, superimposition will not be executed.
- ◆ “EXECUTING” appears and blinks on this transceiver while a series of operations is in progress.
- ◆ In order to use this function, select a SSTV mode other than Fast FM.

TROUBLESHOOTING

The problems described in this table are commonly encountered operational malfunctions and are usually not caused by circuit malfunctions. For the reference pages in parentheses, see the other instruction manual (main).

Problem	Probable Cause	Corrective Action	Ref. Page
Packet operation results in no connects with other stations.	1 The squelch is open.	1 Select the correct squelch level so that the squelch is opened only when signals are present.	(20)
	2 You did not select the same transfer rate as the target station.	2 Use HBAUD command to select the appropriate transfer rate.	4
You did not receive any DX cluster data.	You did not select the APRS mode.	Press [F] (1 s) , [TNC] to enter APRS mode; "TNC APRS" should appear.	6
You cannot transmit any APRS data.	1 Beacon is OFF.	1 Press [F] (1 s) , [BCON] to switch Beacon ON.	25
	2 The squelch is open.	2 Select the correct squelch level so that the squelch is opened only when signals are present.	(20)
	3 The data band is inactive.	3 If you have blanked the data band, press the appropriate [BAND SEL] (1 s) to active it.	(66)
	4 You did not select APRS mode.	4 Press [F] (1 s) , [TNC] to enter APRS mode; "TNC APRS" should appear.	11
	5 You selected Packet mode.	5 Press [F] (1 s) , [TNC] , then [F] (1 s) , [TNC] again; "TNC APRS" should appear.	11
	6 You did not correctly program your call sign.	6 Use Menu 3-1 to correctly program your call sign.	17

Problem	Probable Cause	Corrective Action	Ref. Page
You did not receive any APRS packet.	1 You did not correctly program a group code.	1 Access Menu 3–E and program “APK101”.	22
	2 You did not correctly set the data length and parity bit.	2 Select Packet mode, send the following commands to the TNC, then select APRS mode: AW 8 [ENTER], PAR 0 [ENTER], then RESTART [ENTER]	41, 47, 48
	3 You did not select the appropriate packet transfer rate.	3 Use Menu 3–J to select the appropriate packet transfer rate (generally 1200 bps).	13
When using a GPS receiver with “AUTO” selected in Menu 3–C (PACKET TX), you did not transmit any position data.	The GPS receiver did not yet start correct measurement.	With “AUTO” selected, the transceiver must first receive any NMEA data in order to transmit your position data. (If not using a GPS receiver, access Menu 3–2 and select “NOT USED”).	10
You cannot superimpose information onto the VC-H1 monitor.	You failed to correctly enter information to be superimposed.	Use Menu 2–1 to 2–6 to correctly enter the desired information.	36, 37
You cannot program the VC-H1 with a SSTV mode.	Bad cable connections.	Refer to the instruction manual for the VC-H1 and correctly connect the VC-H1 to the transceiver.	35
You cannot activate Visual Scan, Remote Control (Menu 1–A–3), nor Repeater (Menu 1–7–6).	You selected APRS or Packet mode.	Press [F] (1 s), [TNC] repeatedly so neither “TNC APRS” nor “TNC PKT” is visible.	4, 11

APPENDIX

TNC COMMANDS LIST

The commands supported by the built-in TNC are listed below. You must enter a space between a command name (or short-form) and a parameter, or between two parameters; ex. AU OFF, BEACON EVERY 18.

Command Name	Short	Default	Parameter	Description
8BITCONV	8	ON	ON/ OFF	When ON, handles one character using 8 bits in Converse mode. When OFF, handles one character using 7 bits.
AFILTER	AF	\$00	\$00 ~ \$80	Specifies up to 4 control codes to be removed from received packets when in Converse mode.
AUTOLF	AU	ON	ON/ OFF	When ON, sends a line feed (LF) to the computer after each carriage return (CR).
AXDELAY	AXD	0	0 ~ 120	Specifies the delay time to be added to TXDELAY between PTT ON and start of transmission. The unit of the parameter is 10 milliseconds.
AXHANG	AXH	0	0 ~ 250	Specifies the voice repeater hang time. The unit of the parameter is 100 milliseconds.
BEACON	B	EVERY 0	EVERY/ AFTER n (n = 0 ~ 250)	If set to EVERY, sends a beacon packet at intervals of the specified period (n). If set to AFTER, sends a beacon packet only once after the specified period (n). The unit of n is 10 seconds.
BTEXT	BT	—	0 ~ 159 characters	Specifies the content of the data portion of a beacon packet.
CALIBRAT	CAL	—	—	Sends a space/mark square wave (50/50 ratio). Enter Q to exit Calibrate mode and restore the Command mode.

Command Name	Short	Default	Parameter	Description
CHECK	CH	30	0 ~ 250	Specifies the interval from signal drop-out until execution of disconnection. The unit of the parameter is 10 seconds.
CONMODE	CONM	C	C/ T	With NOMODE set to OFF, causes the TNC to automatically enter C onverse or T ransparent mode when connection is completed.
CONNECT	C	—	Call1 (VIA call2, call3, ... call9)	Sends a connect request. Call1 is the call sign of the station to be connected to. Call2 to call9 are call signs of stations to be digipeated through.
CONOK	CONO	ON	ON/ OFF	When ON, accepts a connect request and returns a UA packet. When OFF, rejects a connect request and returns a DM packet.
CONSTAMP	CONS	OFF	ON/ OFF	When ON, displays the current date and time when connection is completed. The correct date and time must be set using DAYTIME.
CONVERSE	CONV or K	—	—	Causes the TNC to enter Converse mode. Press [Ctrl]+[C] to restore the Command mode.
CPACTIME	CP	OFF	ON/ OFF	When ON and in Converse mode, sends a packet at intervals of the period determined by PACTIME.
CR	CR	ON	ON/ OFF	When ON, appends a carriage return (CR) to all packets to be sent.
DAYSTAMP	DAYS	OFF	ON/ OFF	When ON, pressing [Ctrl]+[T] in Converse mode causes the TNC to send date data in addition to time data.
DAYTIME	DA	—	—	Sets the current date and time. Enter YYMMDDhhmmss. Sets 00 as the second if entry of the second is omitted.
DAYUSA	DAYU	ON	ON/ OFF	When ON, displays the date like MM/DD/YY. When OFF, displays the date like DD-MM-YY.
DIGIPEAT	DIG	ON	ON/ OFF	When ON, allows the TNC to function as a digipeater.
DISCONNE	D	—	—	Sends a disconnect request.

Command Name	Short	Default	Parameter	Description
DISPLAY	DISP	—	—	Causes the TNC to display the current status of all the commands. You can also specify a class identifier A, C, H, I, L, M, or T to display the status of only the desired command class. Enter a space between the command name and a class identifier; ex. DISPLAY H. A (ASYNC): RS-232C port parameters C (CHAR): Special TNC characters H (HEALTH): Counter parameters I (ID): ID parameters L (LINK): TNC-to-TNC link status M (MONITOR): Monitor parameters T (TIMING): Timing parameters
DWAIT	DW	30	0 ~ 250	Specifies the interval from no carrier detection until execution of transmission. The unit of the parameter is 10 milliseconds.
ECHO	E	ON	ON/ OFF	When ON, causes the TNC to echo received characters to the computer.
EPATH	EPATH	—	Call1, ... call7	Specifies digipeater call signs to be added when the UISSID parameter in a received packet is 10 or 14.
EXTCLR	EXTC	—	—	Clears the contents of the TNC mailbox.
FILE	FI	—	—	Displays the list of all messages in the TNC mailbox.
FIRMRNR	FIR	OFF	ON/ OFF	The other station sends a notice (packet) to you if it is not ready to receive data. When ON, receiving such a notice causes the TNC to suspend transmission until it receives a "ready" notice.
FLOVER	FL	0	0 ~ 120	Specifies the time delay from when the TNC buffer becomes full until the TNC buffer is cleared. The unit of the parameter is 1 minute.
FLOW	F	ON	ON/ OFF	When ON, starting key entry causes the computer to stop displaying received packets.

Command Name	Short	Default	Parameter	Description
FRACK	FR	3	0 ~ 15	Specifies the interval from one transmission until retry of transmission. The unit of the parameter is 1 second.
FULLDUP	FU	OFF	ON/ OFF	When ON, allows the TNC to function in full duplex. When OFF, allows it to use data carrier detect signals to avoid packet collision.
GBAUD	GB	4800	4800/ 9600	Selects 4800 or 9600 bps as the transfer rate between the TNC and the GPS receiver.
GPSSSEND	GPSS	—	0 ~ 159 characters	Specifies the content of data to be output to the GPS receiver; this data is used to program the default settings on the receiver. The output data is not stored in memory.
GPSTEXT	GPST	\$PNTS	0 ~ 6 characters	Specifies the type of a message to be determined by LTEXT.
HBAUD	HB	1200	1200/ 9600	Selects 1200 or 9600 bps as the transfer rate between packet stations.
HEALLED	HEAL	OFF	ON/ OFF	Determines whether or not normal operations of the ROM are checked. When ON and if normal operations are detected, "STA" and "CON" appear and blink alternately.
HID	HI	ON	ON/ OFF	When ON, causes the TNC to send an ID packet every 9.5 minutes after digipeating.
ID	I	—	—	Causes the TNC to send an ID packet.
KILL	KI	—	—	Deletes specific messages in the TNC mailbox. Enter KI n to delete one specific message where n is a message number. Enter KI n,n,n..... to delete more than one specific message. Enter KI % to delete 10 messages which have the least numbers. Enter KI & to delete 10 messages which have the largest numbers.

Command Name	Short	Default	Parameter	Description
KISS	KISS	OFF	ON/ OFF	When ON, switching the power OFF then ON causes the TNC to enter (or exit) KISS mode. "STA" and "CON" appear and blink alternately several times when the TNC enters KISS mode. To exit KISS mode, you may send the binary C0 FF C0 command (not ASCII characters) from your keyboard.
LCSTREAM	LCS	ON	ON/ OFF	When ON, changes a small letter (a through z) entered as a stream designator, to a capital letter (A through Z). A stream designator must be entered immediately after STREAMSW.
LIST	LI	—	—	Displays the list of messages, in the TNC mailbox, other than those addressed to other stations.
LOCATION	LOC	EVERY 0	EVERY/ AFTER n (n = 0 ~ 250)	If set to EVERY, sends GPS data at intervals of the specified period (n). If set to AFTER, sends GPS data only once after the specified period (n). The unit of n is 10 seconds.
LOG	LOG	—	—	Displays the list of stations which have connected to the TNC mailbox.
LPATH	LPA	GPS	Call1 (VIA call2, call3, ... call9)	Specifies call signs to send GPS data. Call1 is the call sign of the destination. Call2 to call9 are call signs of stations to be digipeated through.
LTEXT	LT	—	0 ~ 159 characters	Specifies the content of a message to be included in GPS data.
LTMON	LTM	0	0 ~ 250	Specifies the interval for displaying a message determined by LTEXT on the screen; a message appears like a received beacon packet. The unit of the parameter is 1 second.
MAIL	MAI	OFF	ON/ OFF	When ON and the TNC mailbox holds a message addressed to you, outputs "Low" to the MAILLED terminal.
MALL	MA	ON	ON/ OFF	When ON, monitors all packets transferred between other stations. When OFF, monitors only unconnected packets.

Command Name	Short	Default	Parameter	Description
MAXFRAME	MAX	4	1 ~ 7	Specifies the maximum number of packets to be transmitted at one time.
MBOD	MB	OFF	ON/ OFF	When ON, allows the TNC mailbox to be used.
MCOM	MCOM	OFF	ON/ OFF	When ON, causes the TNC to also monitor control packets. When OFF, causes it to monitor only information packets.
MCON	MC	OFF	ON/ OFF	When ON, causes the TNC to monitor other stations while in connection with the target station.
MINE	MI	—	—	Displays the list of messages, in the TNC mailbox, addressed to you and messages that you sent.
MONITOR	M	ON	ON/ OFF	When ON, causes the TNC to monitor packets.
MRPT	MR	ON	ON/ OFF	When ON, causes the TNC to display the entire digipeat list for monitored packets.
MSTAMP	MS	OFF	ON/ OFF	When ON, causes the TNC to display data and time information for monitored packets.
MYALIAS	MYA	—	6 characters + SSID	Specifies a call sign for using your station as a digipeater.
MYCALL	MY	—	6 characters + SSID	Specifies your call sign.
MYMCALL	MYM	—	6 characters + SSID	Specifies a call sign to be assigned to your TNC mailbox.
NEWMODE	NE	OFF	ON/ OFF	When ON, entering a CONNECT command causes the TNC to immediately enter the other mode. When ON and a disconnection takes place, causes it to restore the Command mode. When OFF, causes the TNC to automatically enter the other mode after a connection. When OFF, does not cause it to automatically restore the Command mode after a disconnection.

Command Name	Short	Default	Parameter	Description
NOMODE	NO	OFF	ON/ OFF	When ON, does not cause the TNC to automatically enter the other mode. When OFF, causes it to automatically enter the other mode as specified by NEWMODE.
NPATH	NPATH	—	Call1, ... call7	Specifies digipeater call signs to be added when the UISSID parameter in a received packet is 8 or 12.
NTSGRP	NTSGRP	—	0 ~ 3 characters	Specifies a group code to be used for making a \$PNTS sentence.
NTSMRK	NTSMRK	0	0 ~ 14	Specifies a mark number to be used for making a \$PNTS sentence.
NTSMMSG	NTSMMSG	—	0 ~ 20 characters	Specifies a message to be used for making a \$PNTS sentence.
OVERKILL	OVE	0	0 ~ 255	Specifies the number of old messages to be deleted when the TNC mailbox does not accept a new message because the memory is full.
PACLEN	P	128	0 ~ 255	Specifies the maximum length of the data portion of a packet.
PACTIME	PACT	AFTER 10	EVERY/ AFTER n (n = 0 ~ 250)	If set to EVERY, sends a packet at intervals of the specified period (n). If set to AFTER, sends a packet only once after the specified period (n). The unit of n is 100 milliseconds.
PERSIST	PE	128	0 ~ 255	Specifies a parameter to calculate probability for the PERSIST/SLOTTIME method.
PPERSIST	PP	ON	ON/ OFF	Causes the TNC to use the PERSIST/SLOTTIME method when ON, or the DWAIT method when OFF.
RAMTEST	RAMTEST	—	—	Checks the RAM after clearing it.
READ	R	—	—	Specifies one or more message numbers to be read from the TNC mailbox. Put a comma between message numbers.

Command Name	Short	Default	Parameter	Description
RESET	RESET	—	—	Restores the default status for all the commands.
RESPTIME	RES	5	0 ~ 250	Specifies the acknowledgment packet transmission delay. The unit of the parameter is 100 milliseconds.
RESTART	RESTART	—	—	Causes the TNC to function as if it is switched OFF then ON.
RETRY	RE	10	0 ~ 15	Specifies the number of transmission retries. If packets are not correctly accepted while in connection, a connect request is sent again after the specified number of retries.
ROUTE	ROU	ON	ON/ OFF	When ON and receiving a packet forwarded by a PBBS, leaves the included route information. When OFF, deletes the included route information.
SENDPAC	SE	\$0D	0 ~ \$7F	Specifies a character which forces a packet to be sent.
SLOTTIME	SL	3	0 ~ 250	Specifies the period of random number generation intervals for the PERSIST/SLOTTIME method. The unit of the parameter is 10 milliseconds.
SPATH	SPATH	—	Call1, ... call7	Specifies digipeater call signs to be added when the UISSID parameter in a received packet is 9 or 13.
STREAMCA	STREAMC	ON	ON/ OFF	When ON and multiple connections take place, receiving a packet causes the TNC to display the call sign.
STREAMDB	STREAMD	OFF	ON/ OFF	When ON, causes the TNC to display a streamswitch character included in a received packet.
STREAMSW	STR	\$01	0 ~ \$7F	Specifies a character to be used for switching streams.
TOUT	TOUT	30	0 ~ 250	Specifies the time-out time of the TNC mailbox. When no packet is received within the specified time, a disconnect takes place. The unit of the parameter is 10 seconds.
TRACE	TRAC	OFF	ON/ OFF	When ON, causes the TNC to display all received packets in their entirety.

Command Name	Short	Default	Parameter	Description
TRANS	T	—	—	Causes the TNC to exit Command mode and enter Transparent mode. To restore Command mode, press and hold [Ctrl] , then press [C] three times.
TRFLOW	TRF	OFF	ON/ OFF	When ON, causes the TNC to respond to software flow control from the computer in Transparent mode.
TRIES	TRI	0	0 ~ 15	Specifies the number of transmission retries programmed in the retry counter.
TXDELAY	TX	50	0 ~ 120	Specifies the time delay between PTT ON and start of transmission. The unit of the parameter is 10 milliseconds.
TXFLOW	TXF	OFF	ON/ OFF	When ON, allows the TNC to send a software flow control (XON and XOFF) to the computer in Transparent mode.
UICHECK	UIC	28	0 ~ 250	Does not forward the same UI packet as one received within the time specified by this command. The unit of the parameter is 1 second.
UIDIGI	UI	OFF	OFF/ ON Call1, ... call14	When receiving a UI packet which includes the parameter specified by this command, replaces the parameter with the MYCALL parameter and forwards the packet.
UIDWAIT	UIDW	OFF	ON/ OFF	When ON and digipeating, causes the TNC to use the DWAIT and PERSIST settings.
UIFLOOD	UIF	NOID	ID/ NOID/ FIRST	Specifies how received UI packets, which include WIDEN-N or TRACEN-N parameters, are processed. Enter WIDE or TRACE before ID, NOID, or FIRST; ex. WIDE,FIRST. With ID selected, deletes the relayed digipeaters and adds the MYCALL parameter. With NOID, merely decrements N-N; ex. 4-3 to 4-2. With FIRST, adds the MYCALL parameter only when serving as the first digipeater.
UISSID	UIS	OFF	ON/ OFF	When ON, causes the TNC to process received UI packets depending on included destination SSIDs.

Command Name	Short	Default	Parameter	Description
UITRACE	UIT	—	—	The command name must be followed by up to 5 alphanumeric characters; normally WIDE or TRACE. Causes the TNC to forward received UI packets which include WIDEN-N or TRACEN-N parameters.
UNPROTO	U	CQ	Call1 (VIA call2, call3, ... call9)	Specifies call signs to send a packet in Unprotocol mode. Call1 is the call sign of the destination. Call2 to call9 are call signs of stations to be digipeated through.
USERS	US	1	0 ~ 10	Specifies the number of channels available to connect requests.
WRITE	W	—	—	Allows the TNC mailbox to store your message. In order to permit only a specific station to read your message, enter a call sign after the command name; ex. W JA1YKX. To complete message entry, press [Enter] (or [Return]), [Ctrl]+[C] , then [Enter] (or [Return]). For a subject, you can enter up to 30 alphanumeric characters.
XFLOW	X	ON	ON/ OFF	Causes the TNC to perform software flow control when ON, or hardware flow control when OFF.

Downloaded by **RadioAmateur.EU**

INDEX

APRS

Call Sign, Programming 17
Data Band 13
Digipeater 9, 27
GPS Receiver 10
Grid Square Locator 16, 19
Group Code 22
Mic Encoder 16
NMEA 8, 10
Object 14, 16
Packet Monitor Display 26
Packet Path 9, 23
Packet Transmit Interval 25
Packet Transmit Method 25
Position Ambiguity 26
Position Comment 16, 20
Position Data 16, 19
Receiving 14
Reception Distance
Restriction 26
Station Icon 18
Status Text 16, 21
Status Text Transmit Rate ... 25

Transmitting 25
Weather Station 8, 16
APRS Message
Auto Answer Reply 33
Entering 30
Group Code 34
Receiving 29
Transmitting 32
DX Packetclusters Monitor 6
Internal Clock, Adjusting
Date 12
Time 12
UTC Offset 13
Packet Operation
Command Mode 3
Converse Mode 3
Data Band 5
DCD Sense 5
Mailbox 3
PBBS 1
TNC 3
PACSAT 7

Slow-Scan Television (SSTV)

Call Sign Entry 36
Color Change 37
Message Entry 36
Mode Change 38
RSV Report Entry 36
Superimposition 37
VC-H1 Control 38

KENWOOD

Downloaded by
RadioAmateur.EU